

## Ecophon Wall Panel C

2700x600  
M195

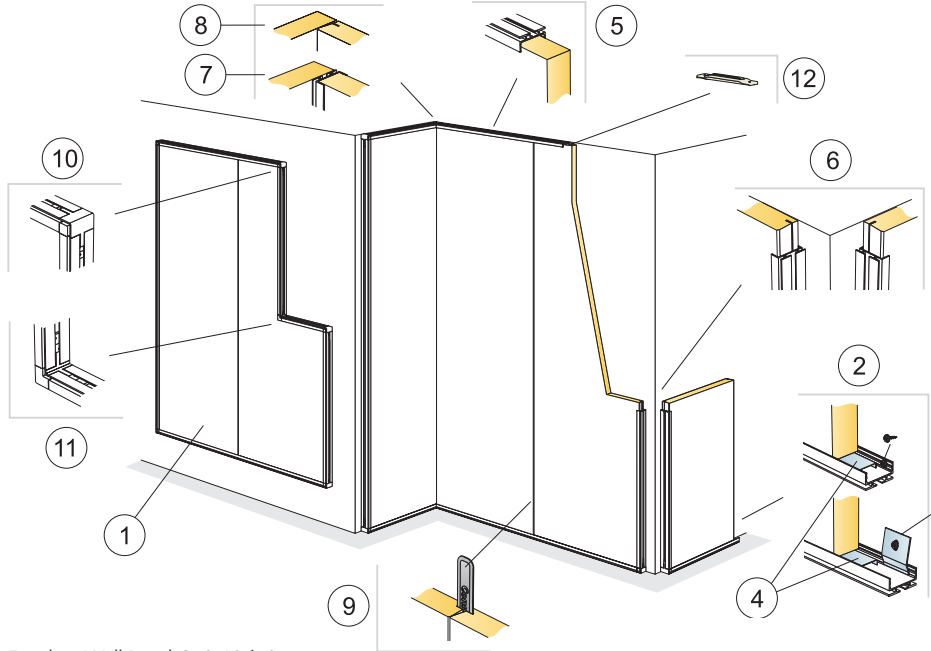

1. Ecophon Wall Panel C 0,62/m<sup>2</sup>

2. Connect WP Profile, L=2687 mm, fixed (alt. with Connect Fixing bracket), at 400 mm centres, with Connect WP Space bar, L=2400 mm

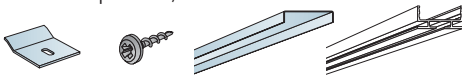

3. Alt. 1: Connect Fixing bracket, fixed at 400 mm centres.



4. Connect WP Space bar, L=2400 mm

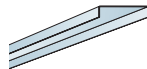

5. Connect WP Profile, L=2687 mm, fixed at 400 mm centres



6. External wall corner: Connect WP Profile, L=2687 mm, fixed at 400 mm centres

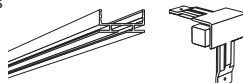

7. Internal wall corner: Cut panel and Connect WP Profile, L=2687 mm alt. full size panel without profile

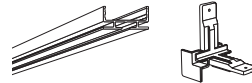

8. Alt. Full size panel without profile

9. Joint between panels (Connect Spline can be used to secure the panels)



10. Connect WP External corner mounted in Connect WP Profile

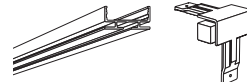

11. Connect WP Internal corner mounted in Connect WP Profile

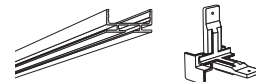

12. Connect WP profile splice



**Ecophon**<sup>®</sup>  
SAINT-GOBAIN

A SOUND EFFECT ON PEOPLE

[www.ecophon.com](http://www.ecophon.com)

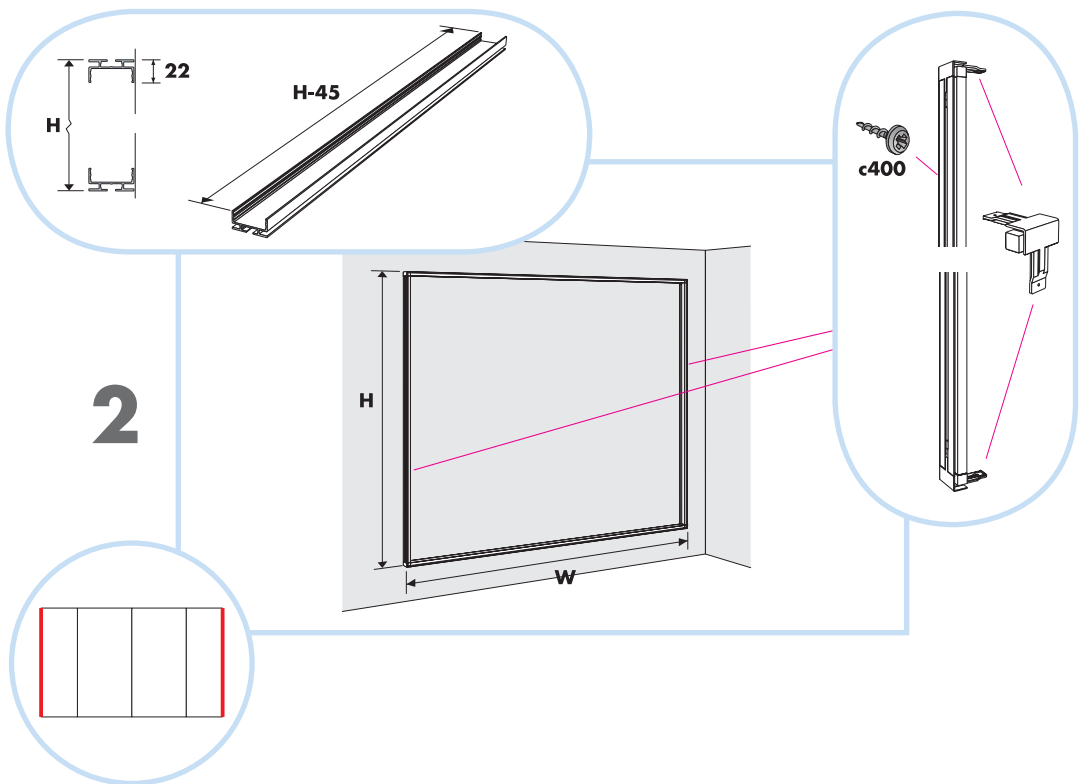
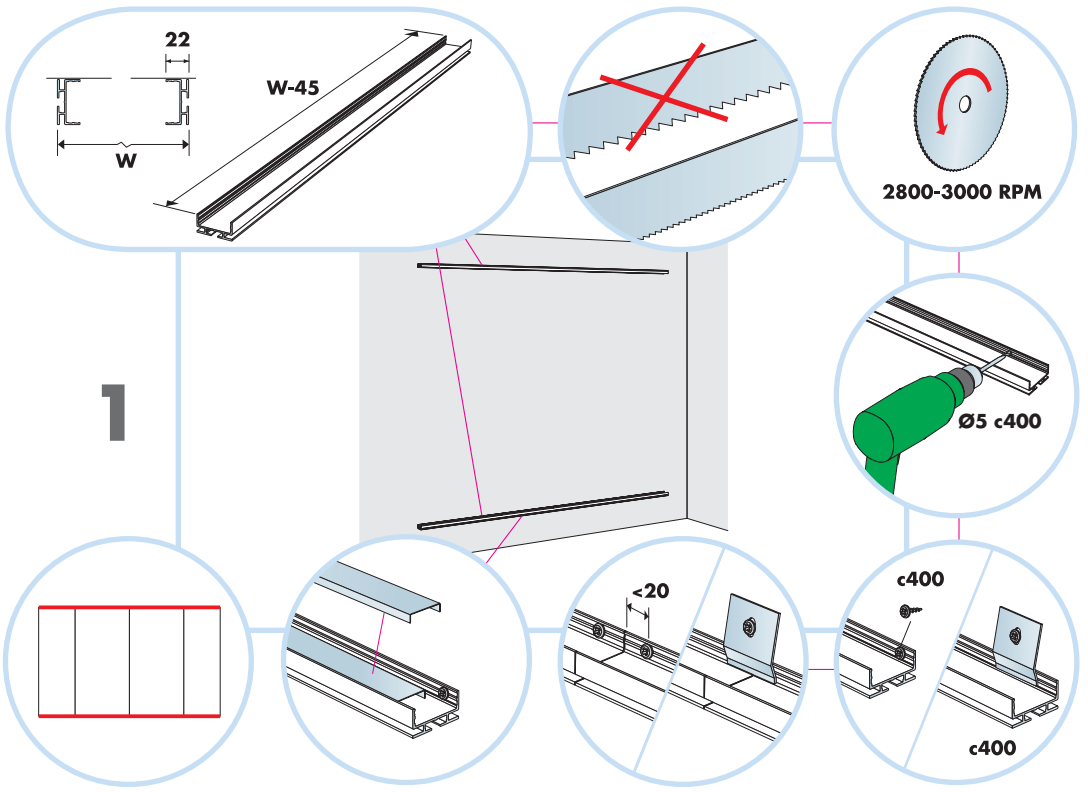

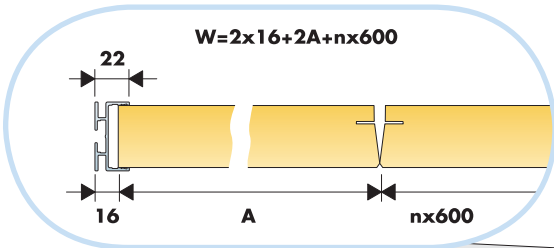

**3**

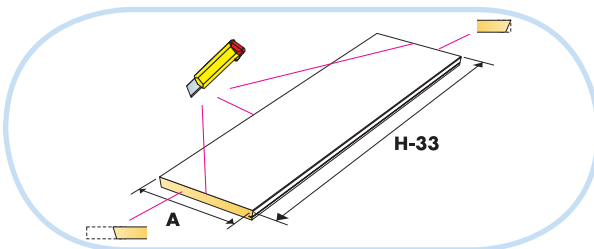
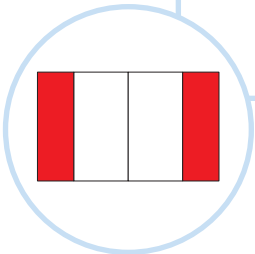
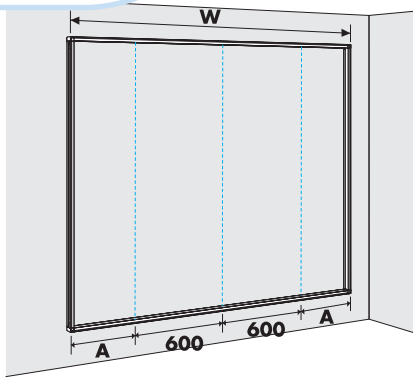

**4**

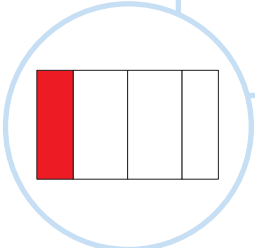
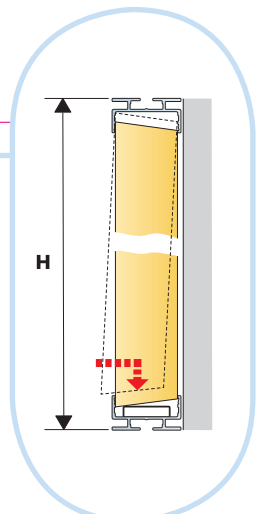
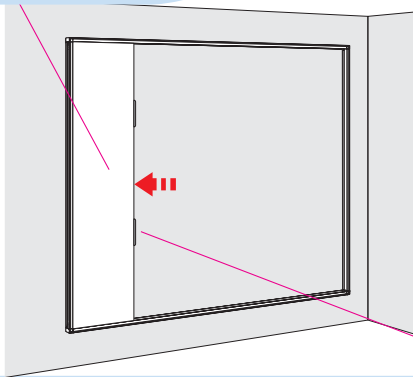

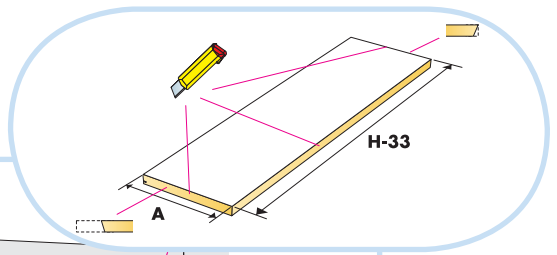
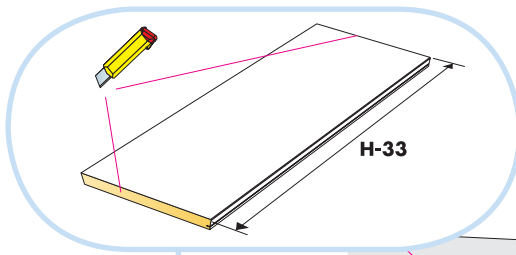

5

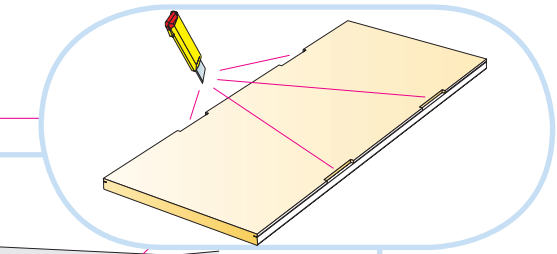
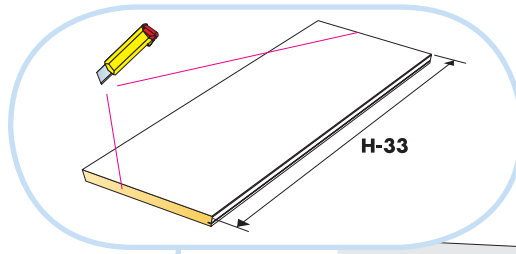
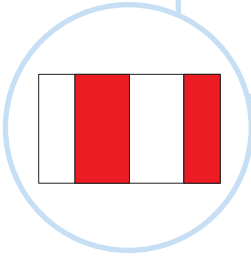
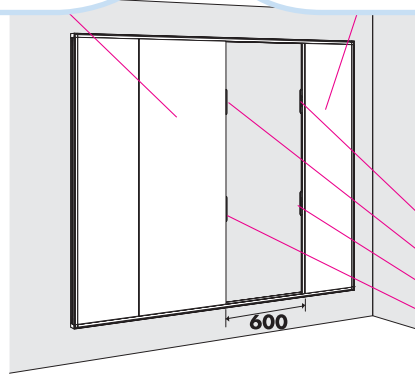

6

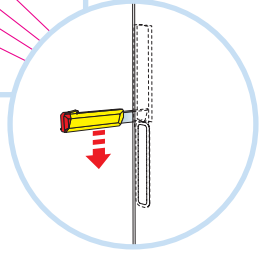
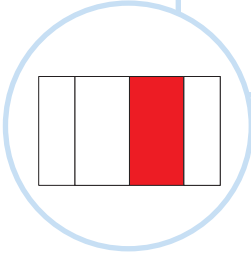
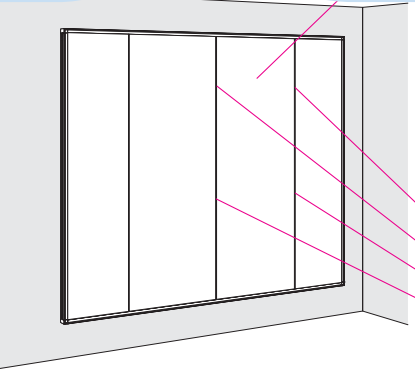

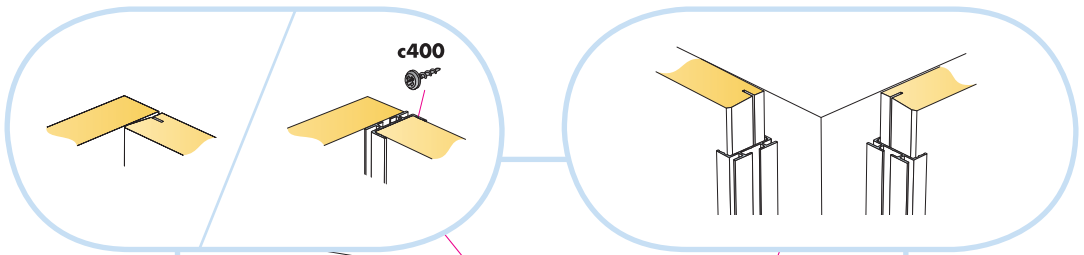

7

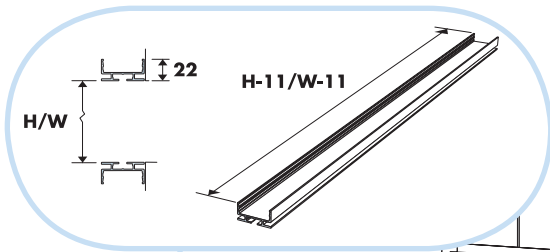
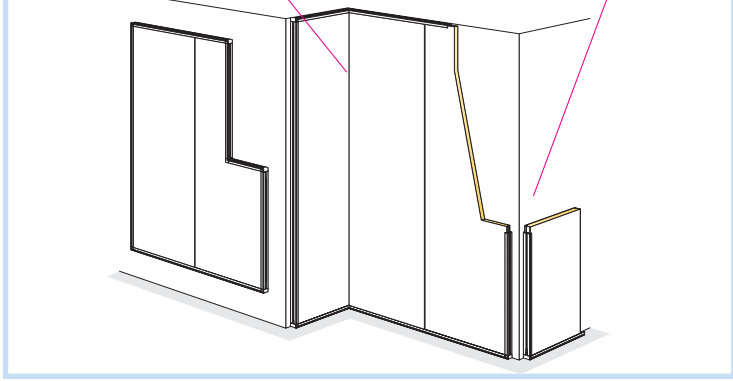

8

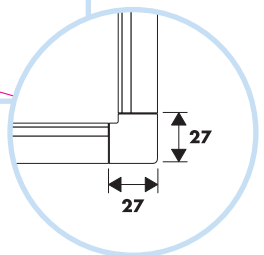
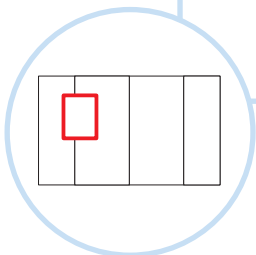
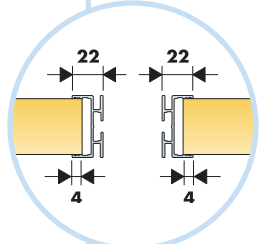
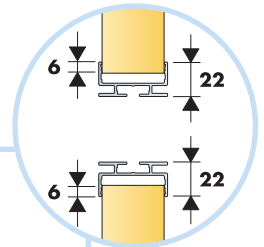
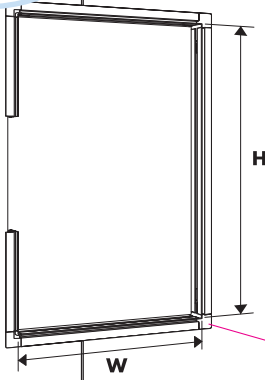

9

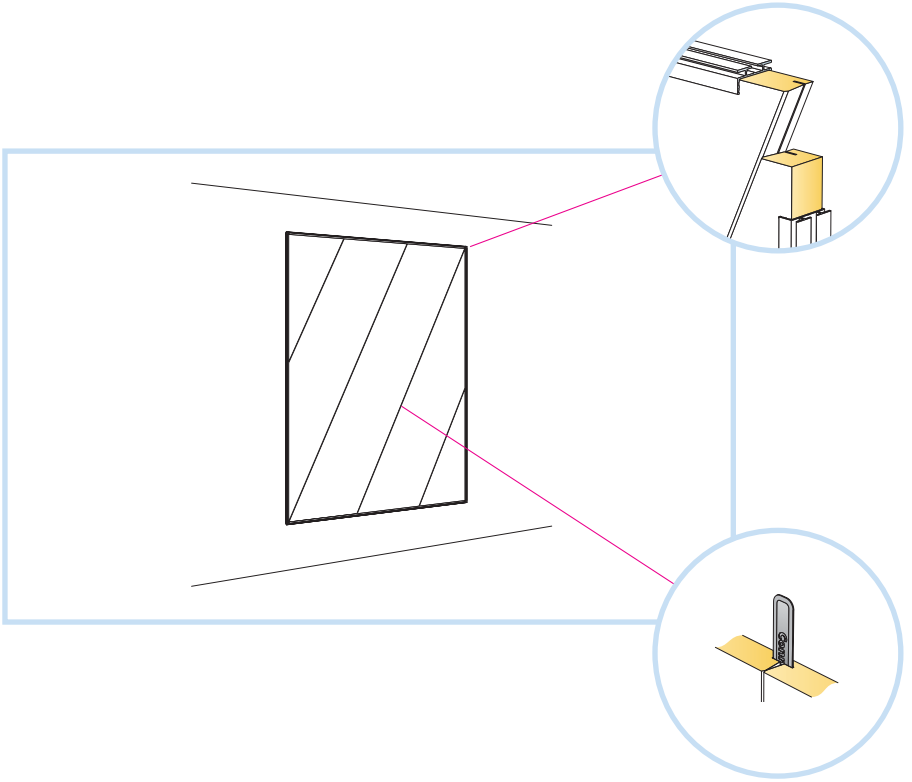

**B > 2700**

10

