

# Ecophon Wall Panel C with Thinline

Horizontal installation 2700x600

**M303**

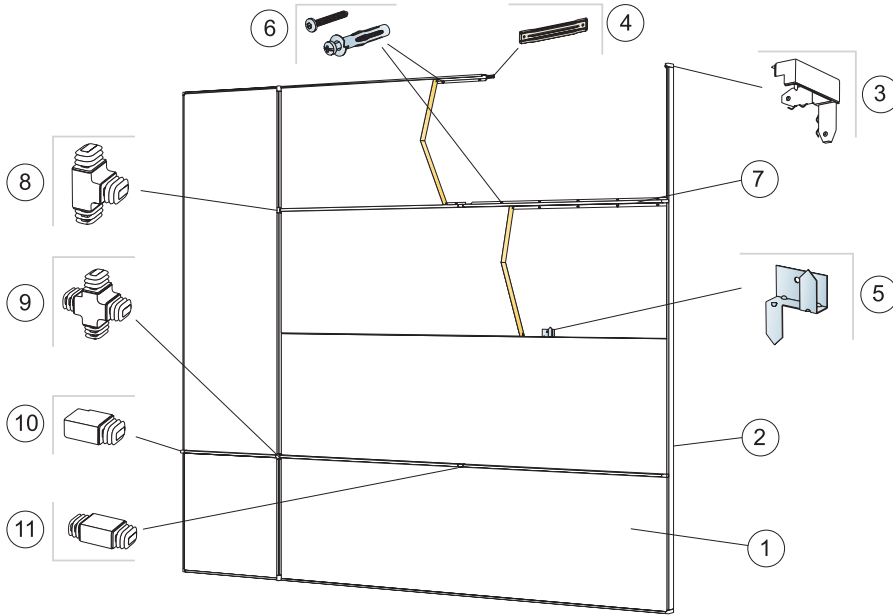

1. Ecophon Wall Panel C.

2. Connect Thinline profile.

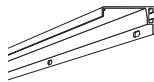

3. Connect Thinline corner.



4. Connect Thinline splice.



5. Connect Ambit fixing.



6. Installation screw, installed at 200 mm centres (select fastener according to wall material).



7. Connect Structure profile.

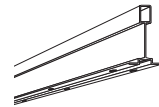

8. Connect Structure T-junction.



9. Connect Structure X-junction.



10. Connect Structure ending.



11. Connect Structure I-junction.



**Ecophon**<sup>®</sup>  
SAINT-GOBAIN

---

A SOUND EFFECT ON PEOPLE

[www.ecophon.com](http://www.ecophon.com)

# 1

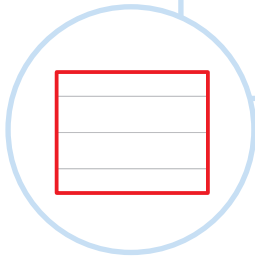
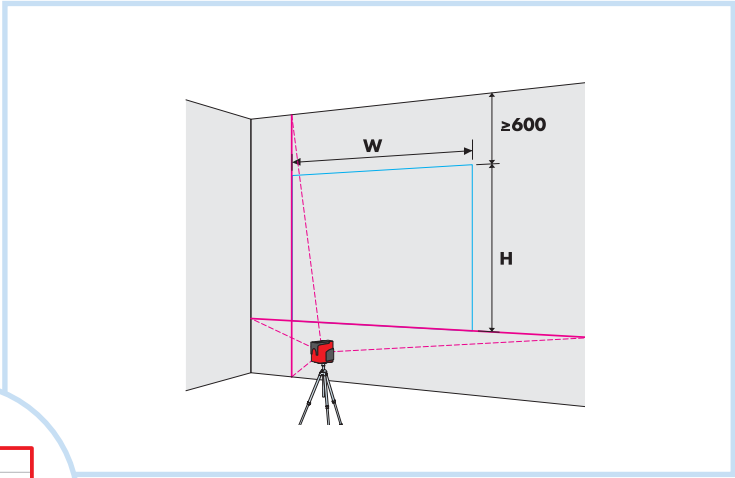

# 2

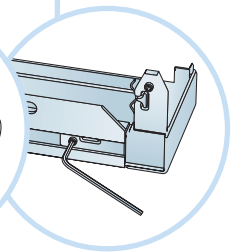
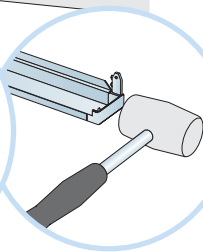
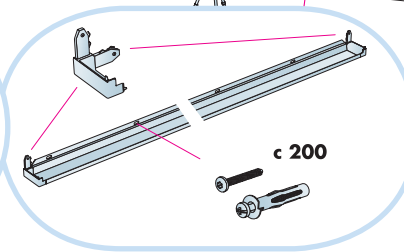
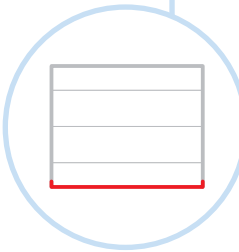
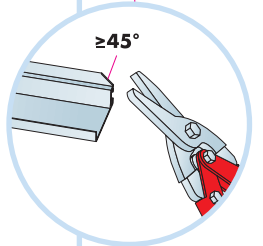
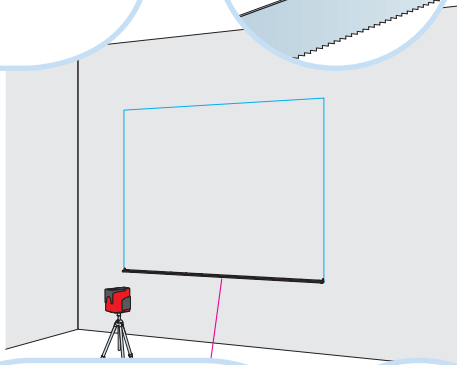
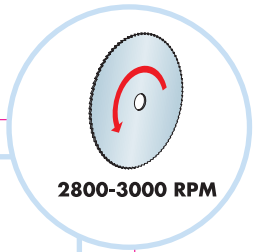
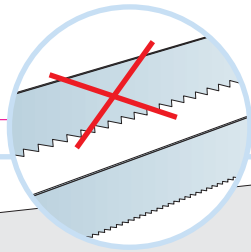
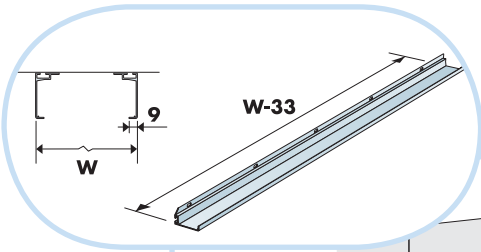

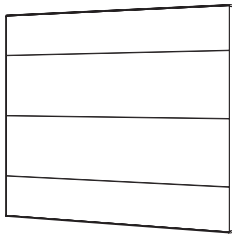
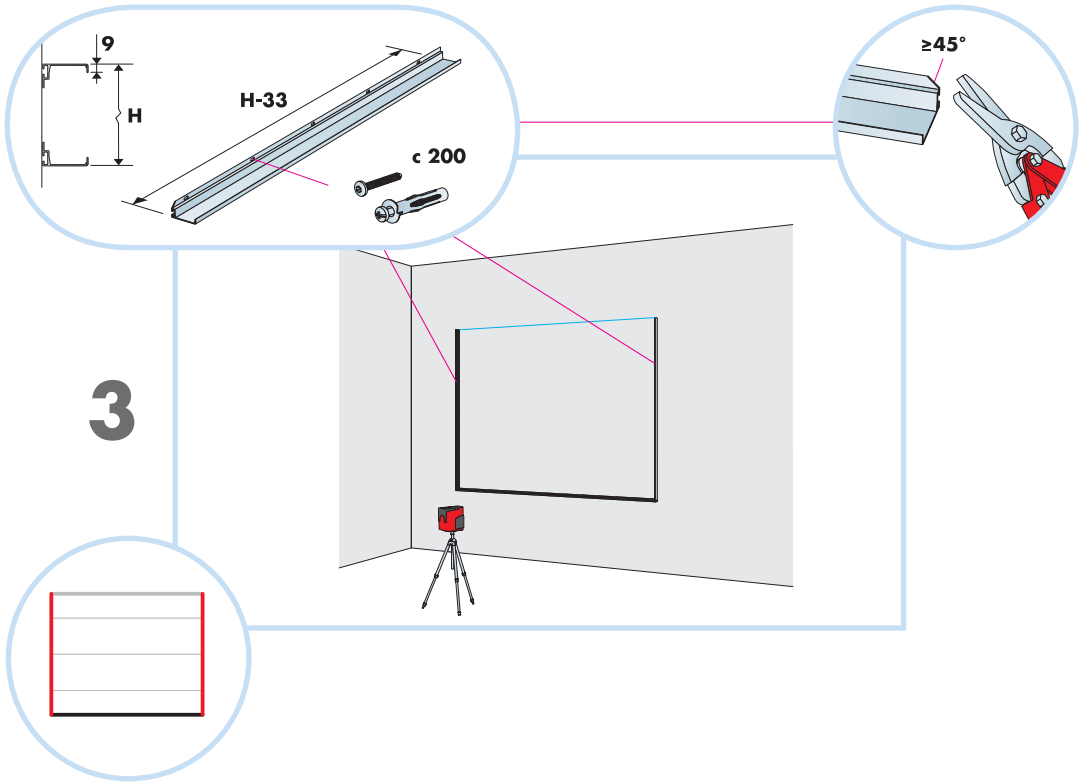

→ **4**

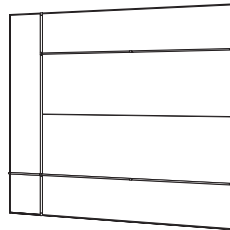

→ **8**

4

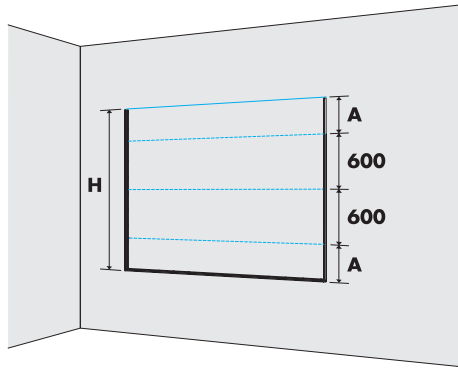

$$H=2A+nx600$$

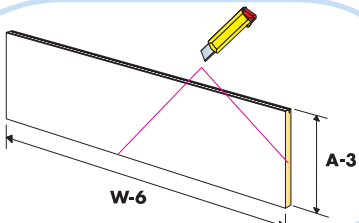
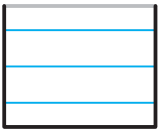
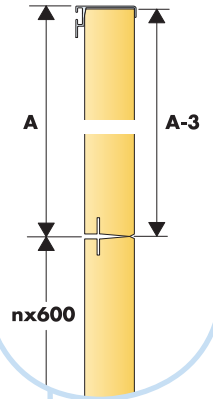

c 1000

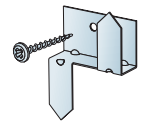

5

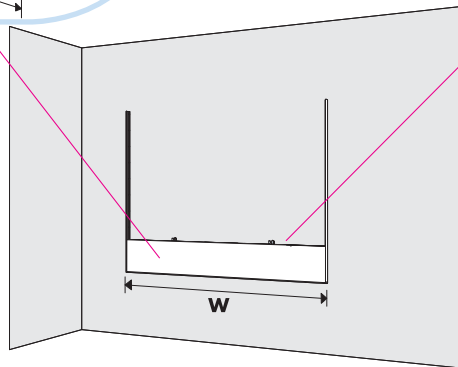

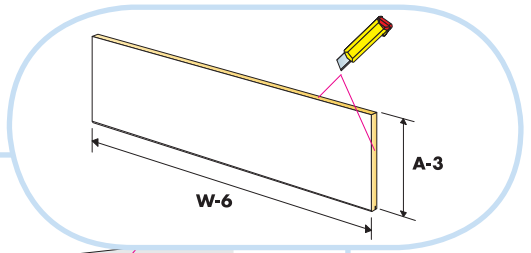
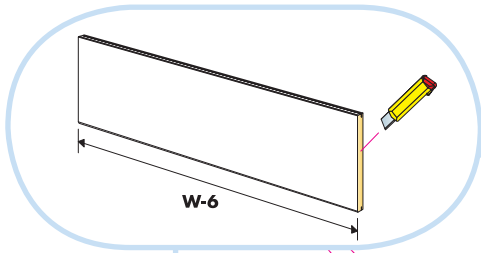

6

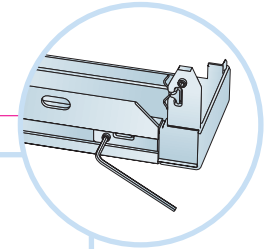
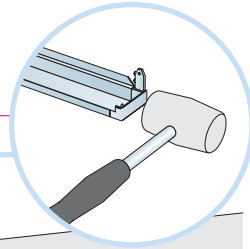
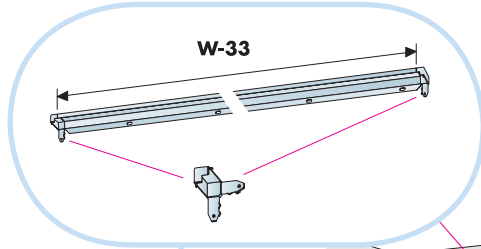
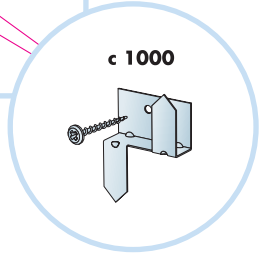
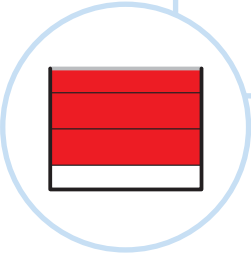
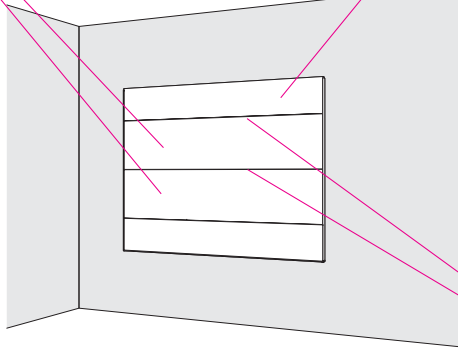

7

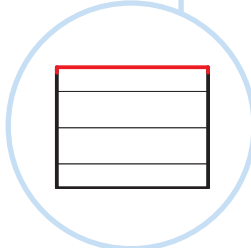
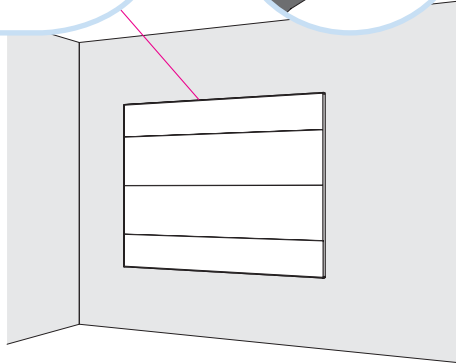

**H/W > 2700**

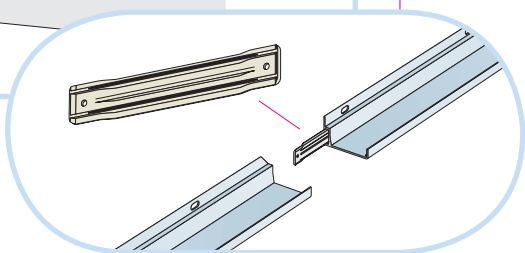
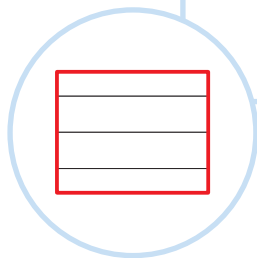
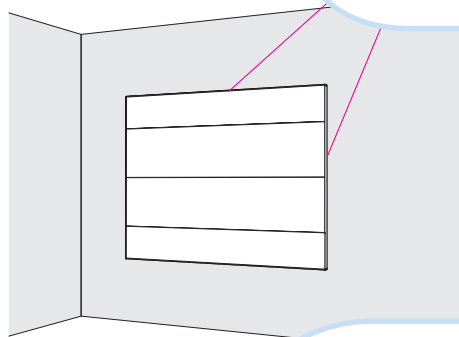
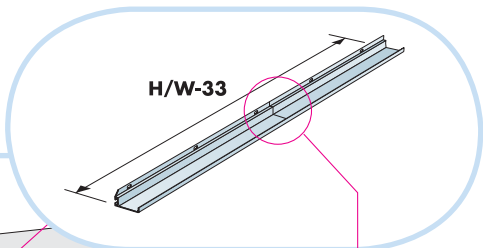

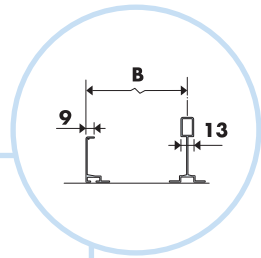
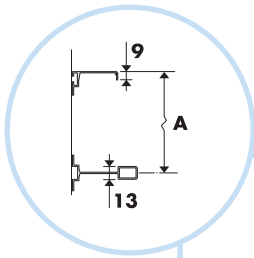

8

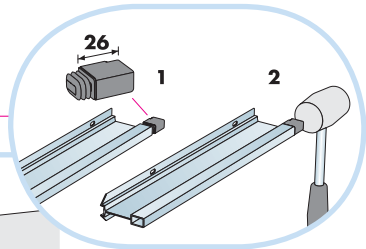
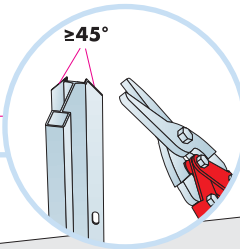
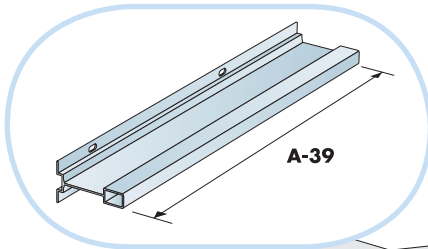
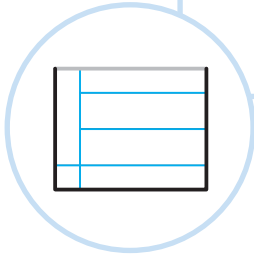
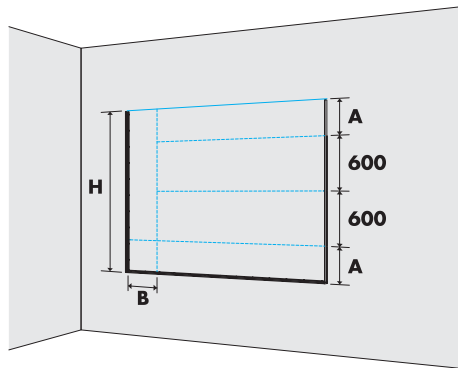

9

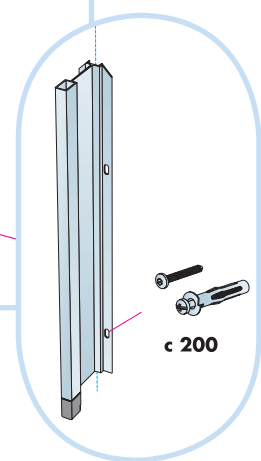
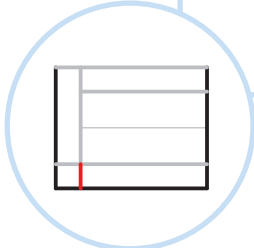
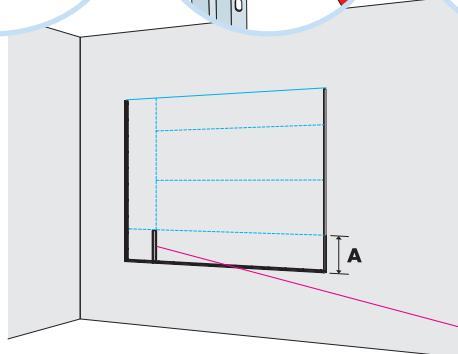

# 10

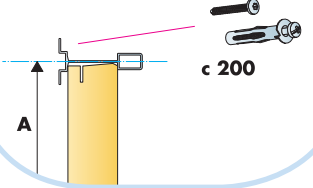
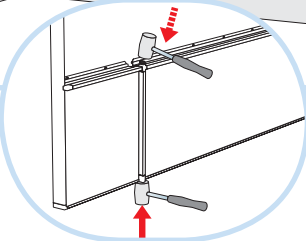
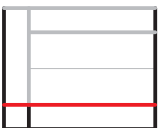
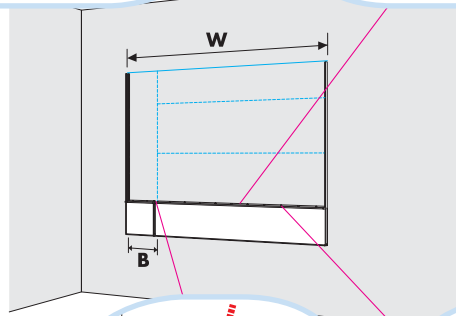
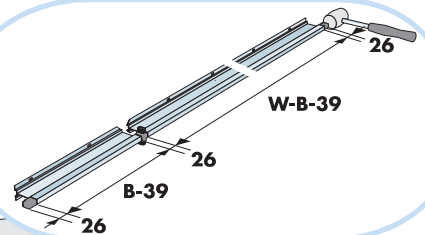
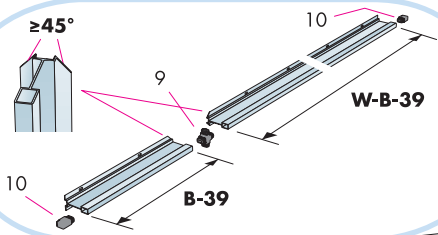
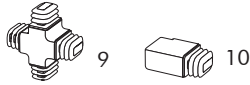
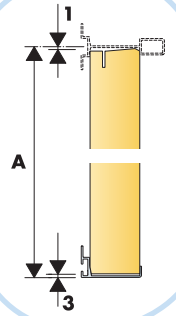
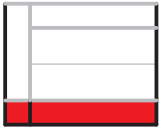
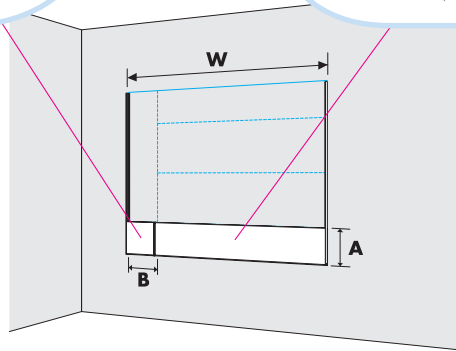
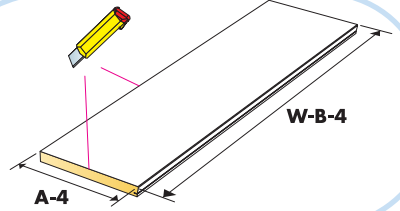
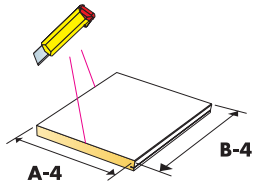

# 11

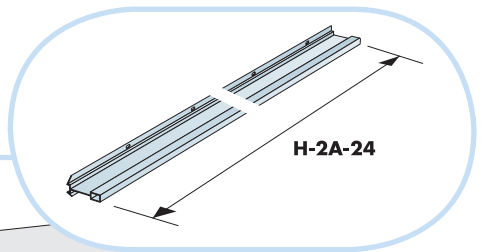
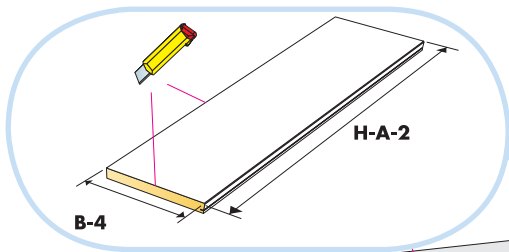

12

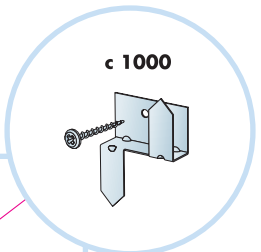
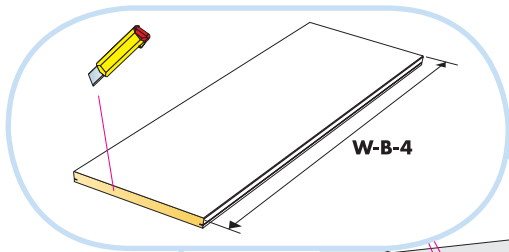
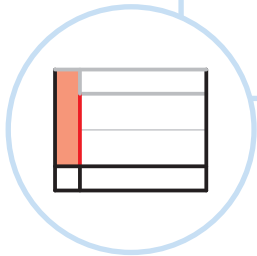
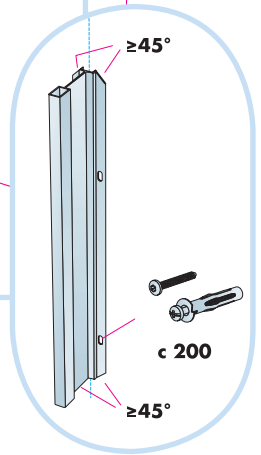
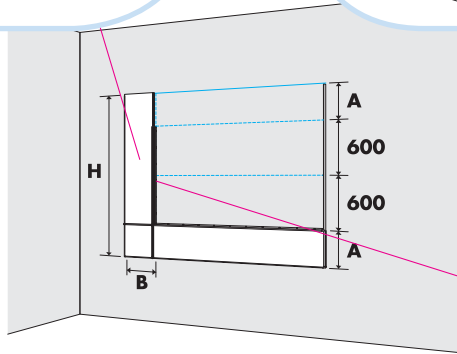

13

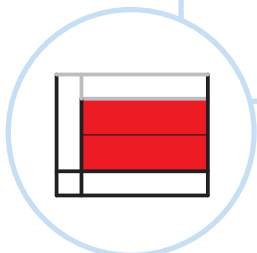
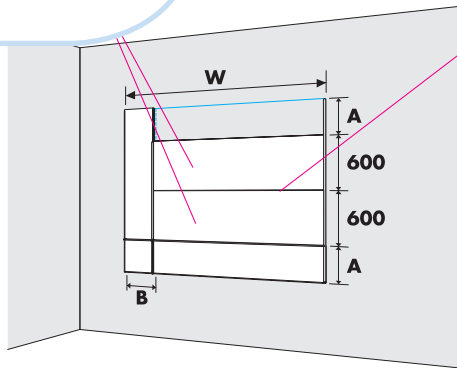

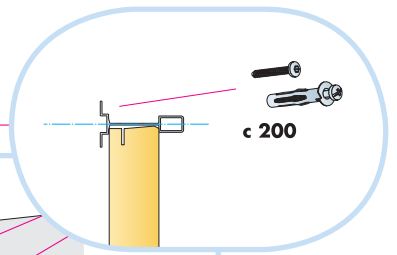
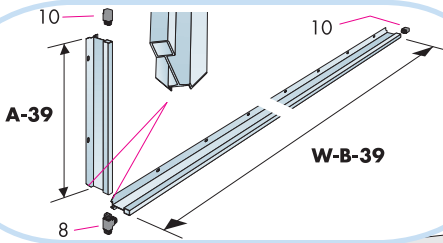

14

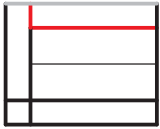
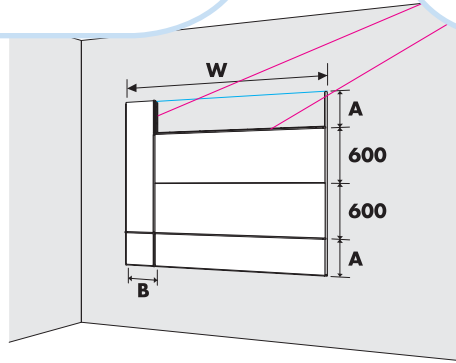

15

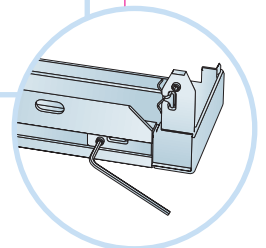
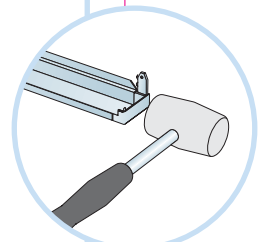
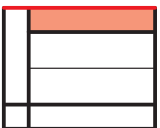
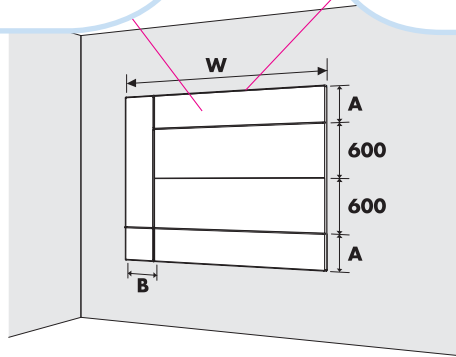
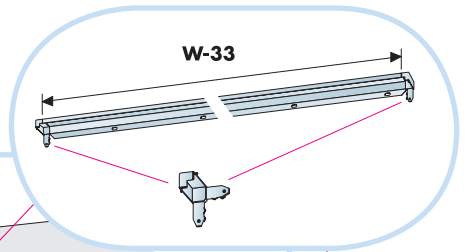
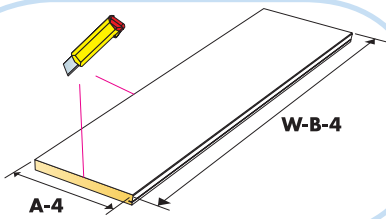

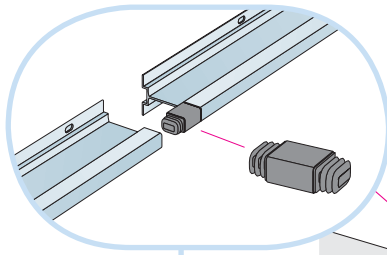

**H/W > 2700**

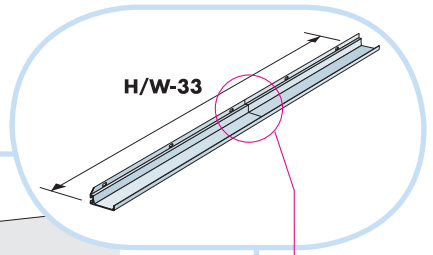

**H/W-33**

