

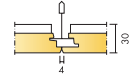

ECOPHON COMBISON™ UNO DS

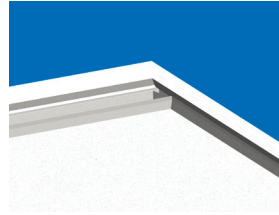

For use as a sound absorbing ceiling and for sound insulation between rooms if the partitions do not extend all the way up to the soffit. Also suitable for sound reduction of vertical noise, generated by ventilation, foot steps etc. Ecophon Combison Uno Ds is installed in a suspended grid system, creating a ceiling with a smooth appearance. The bevelled edges create a narrow groove between each tile. The tiles are demountable.



Combison Uno Ds tile.

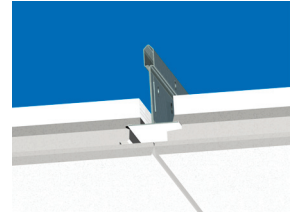

Section of Combison Uno Ds system.

The system consists of Ecophon Combison Uno Ds tiles and Ecophon Connect grid systems, with an approximate weight of 11 kg/m². The tiles are manufactured from high density glass wool, with a bonded gypsum board (9 mm) on the back of the tile. The visible surface has an Akutex™ FT coating and the edges are primed.

For best performance and system quality, use Ecophon Connect grid and accessories. The grid is manufactured from galvanized steel.

SYSTEM RANGE

Size, mm	600 x 600
T24	•
Thickness	30
Inst. Diagr.	M241

TECHNICAL PROPERTIES

ACOUSTIC Sound Absorption Test results according to EN ISO 354. Classification according to EN ISO 11654, and the single value ratings for NRC and SAA according to ASTM C 423.

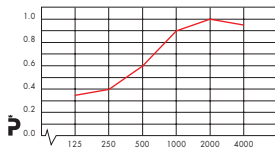

Product	Combison Uno Ds
o.d.s mm	200
absorption class	C
NRC	
SAA	
α_w	

Sound Insulation $D_{n,w}$ = 39-41 dB according to ISO 140-9 and evaluation according to ISO 717.

Sound Privacy Not applicable

ACCESSIBILITY The tiles are easily demountable. Minimum demounting depth according to installation diagrams.

CLEANABILITY Daily dusting and vacuum cleaning. Weekly wet wiping.

VISUAL APPEARANCE White Frost, nearest NCS colour sample S 0500-N, 85% light reflectance (of which more than 99% is diffuse reflection). Retro reflection coefficient 63 mcd*m-2lx-1. Gloss < 1.

INFLUENCE OF CLIMATE The tiles withstand a permanent ambient RH up to 75% at 30°C without sagging, warping or delaminating (ISO 4611).

INDOOR CLIMATE Recommended by the Swedish Asthma and Allergy Association.

ENVIRONMENTAL INFLUENCE Fully recyclable

FIRE SAFETY The glass wool core of the tiles is tested and classified as non-combustible according to prEN ISO 1182. The systems are classified as fire protective covering according to NT FIRE 003. See Technical properties, Fire safety.

Reaction-to-fire classification

Country	Standard	Class
Europe	EN 13501-1	A2-s1,d0

MECHANICAL PROPERTIES For information regarding live load and requirements for load bearing capacity, see installation diagrams. Conditions: See Functional demands, Mechanical properties.

INSTALLATION Installed according to system range which includes information regarding minimum overall depth of system.

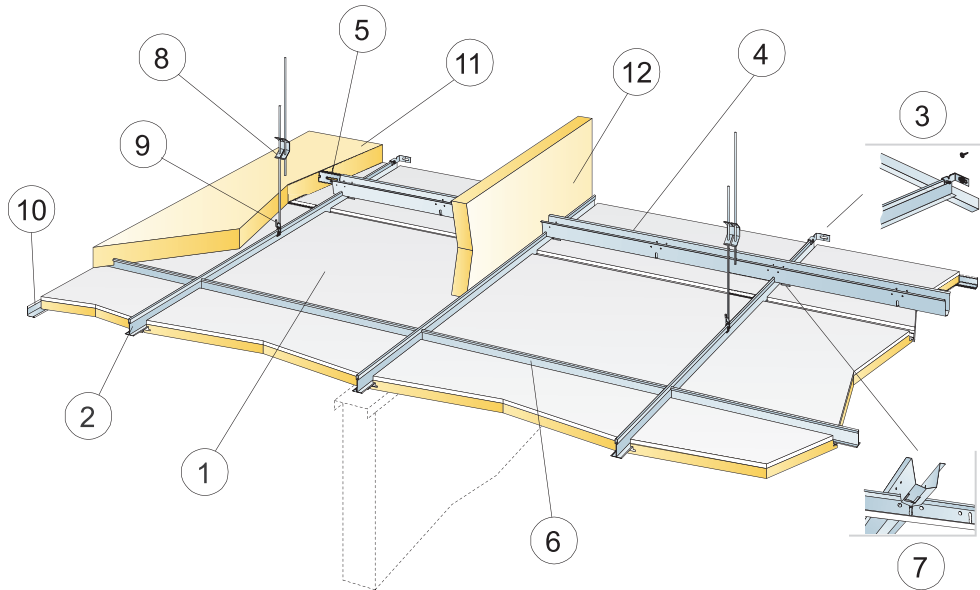

© Ecophon Group

QUANTITY SPECIFICATION (EXCL. WASTAGE)

	Size, mm
	600x600
1 Ecophon Combison Uno Ds	2,8/m ²
2 Connect T24 Main runner HD, installed at 600 mm centres	1,7m/m ²
3 Connect Wall bracket for T-profiles	1 for every row of suspended Main runner HD
4 Connect Space bar, installed at 1500 mm centres (max. distance from wall 300 mm)	0,7m/m ²
5 Connect Wall bracket, L=700 mm, for Space bar	1 for every row of Space bar
6 Connect T24 Cross tee, L=600 mm	2 per row of Main runner
7 Connect Space bar winch, installed one per joint Main runner/Space bar	1,4/m ²
8 Connect T24 Cross tee, L=1200 mm, installed at 600 mm centres	0,7/m ²
9 Connect Hanger clip	0,7/m ²
10 Connect Angle trim, fixed at 200 mm centres	as required
11 Combison XR (if required)	as required
12 Combison Barrier (if required)	as required
Δ Min. overall depth of system: 105 mm	
δ Min. demounting depth: 40 mm	

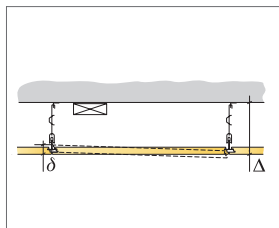

See Quantity specification

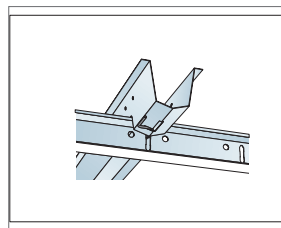

Connection between profiles with space bar winch

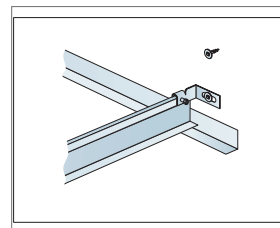

Connect Wall bracket for T-profiles

Size, mm	Max live load [N]	Min load bearing capacity [N]
600x600	0	220

Live load/load bearing capacity