

Ecophon Akusto Wall A

2700x1200

M353

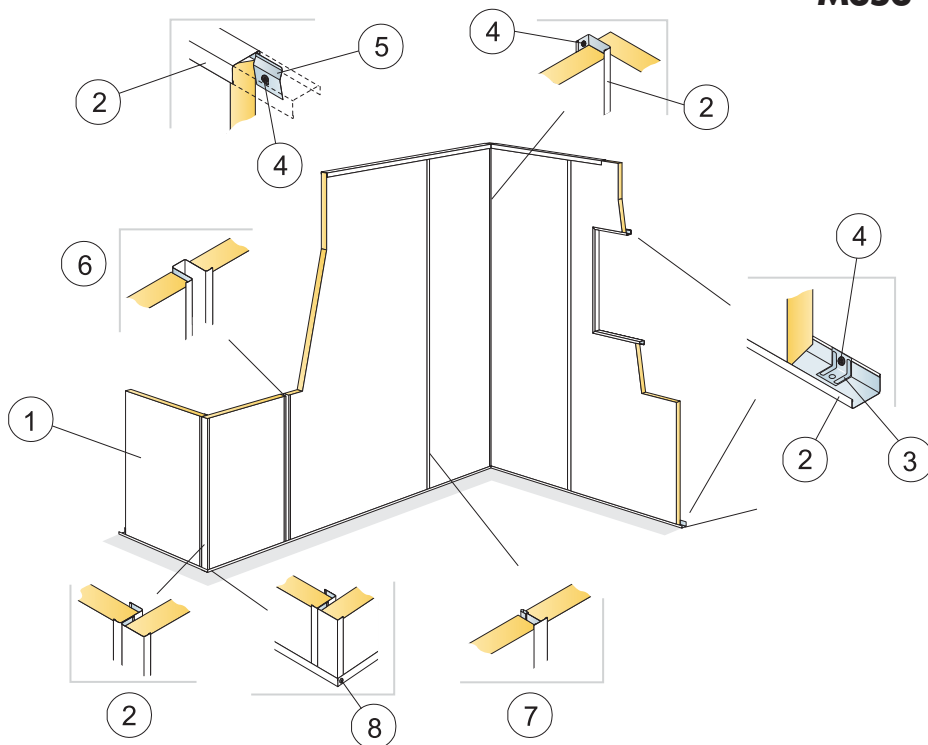

1. Ecophon Akusto Wall A

2. Connect Channel trim,
L=2700/3000 mm, H=44 mm

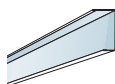

3. Connect Direct fixing plate



4. Connect Installation screw MVL



5. Connect Fixing bracket



6. Alt. 1 Connect Recessed profile,
L=2700/2800, W=55 mm

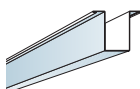

7. Alt. 2 Connect T24 Main runner,
L=3700 mm, W=24 mm

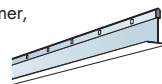

8. Connect Installation screw BR



Ecophon[®]
SAINT-GOBAIN

A SOUND EFFECT ON PEOPLE

www.ecophon.com

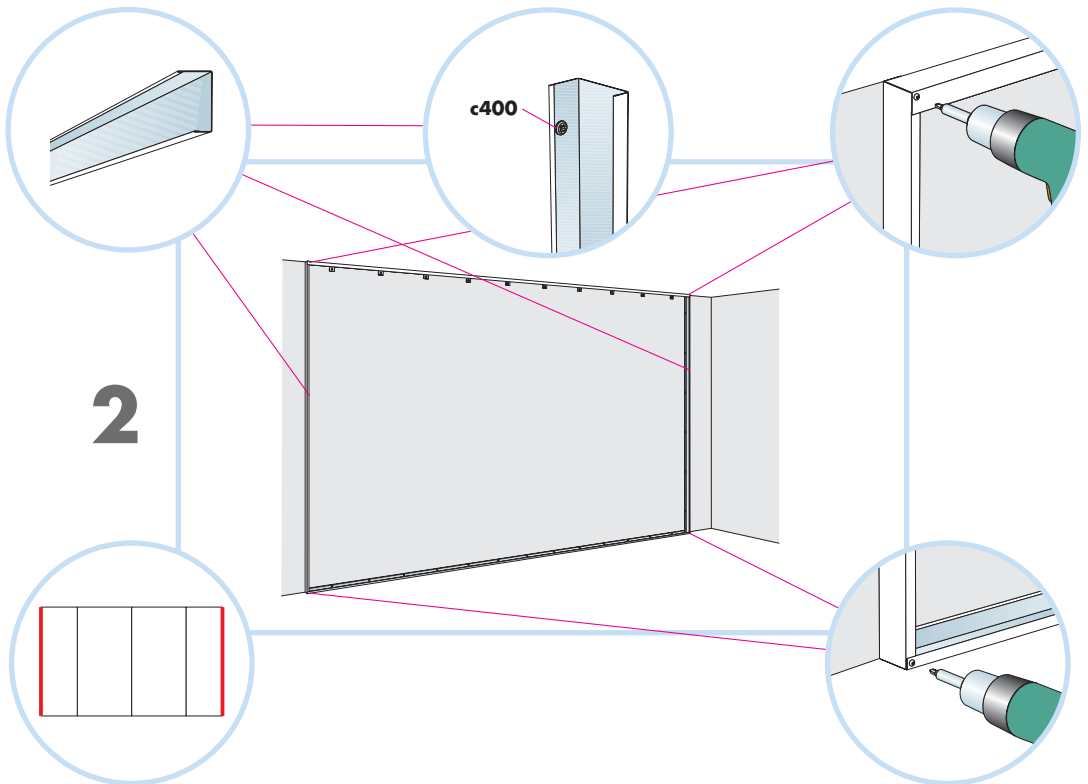
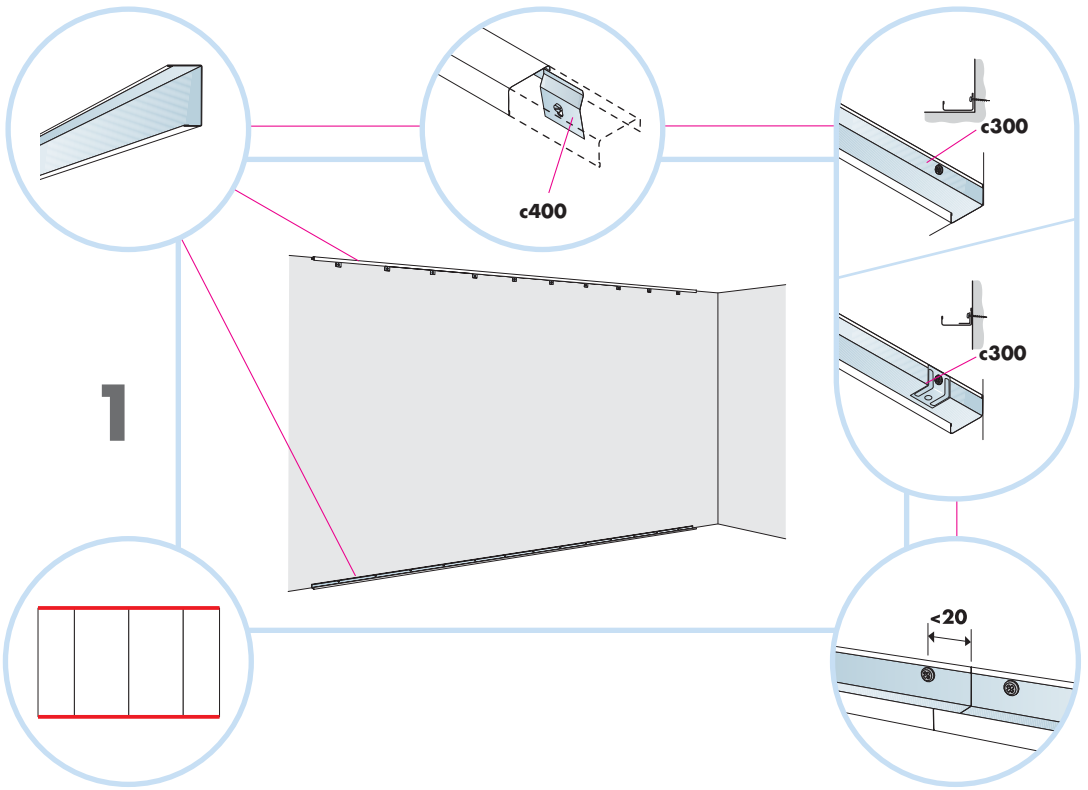

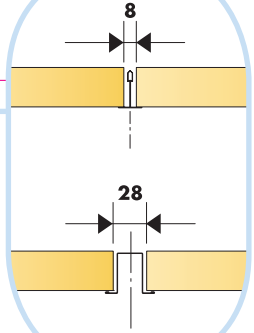
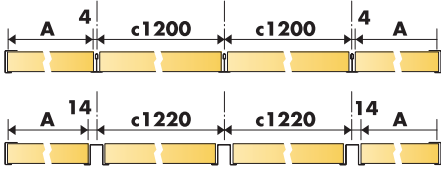

3

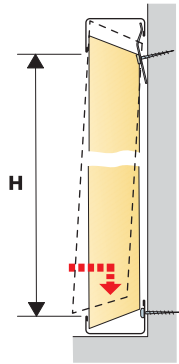
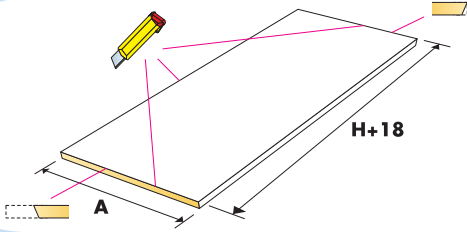
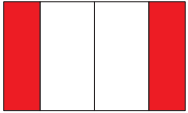
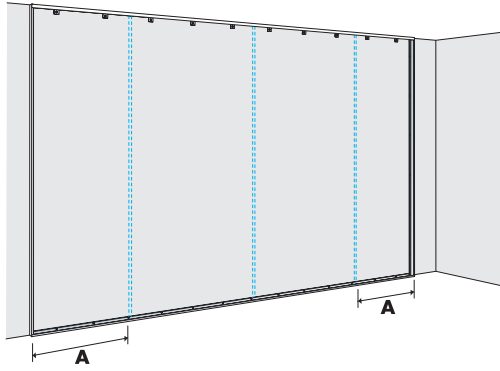

4

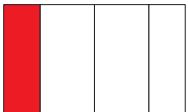
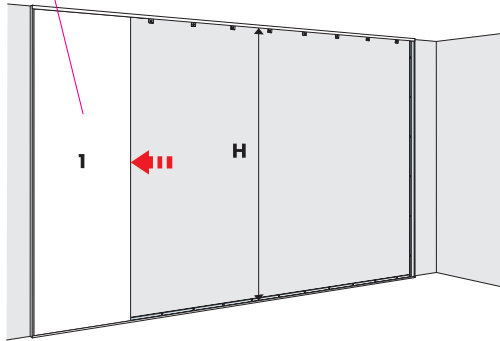

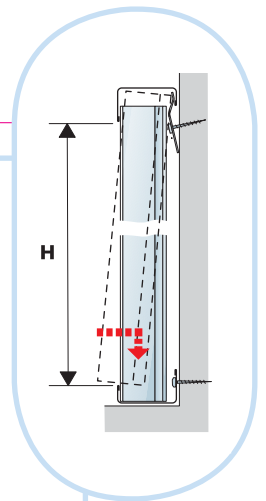
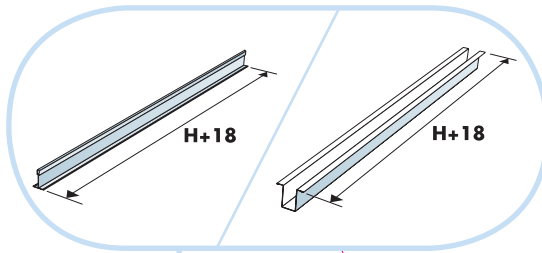

5

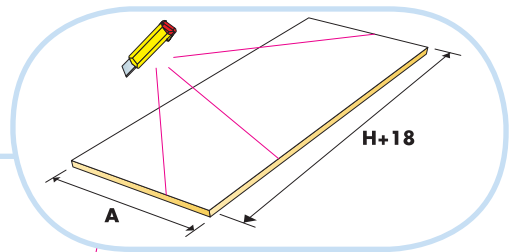
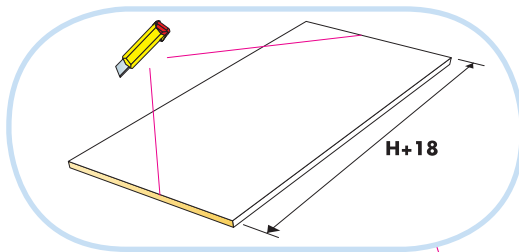
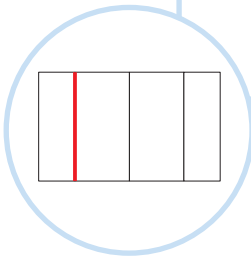
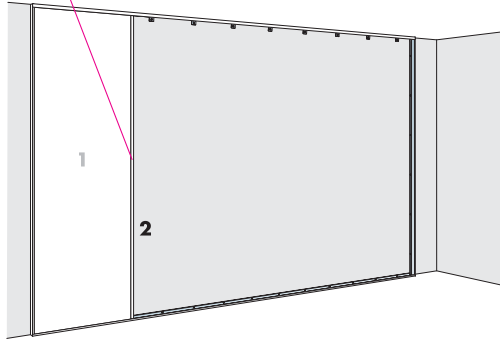

6

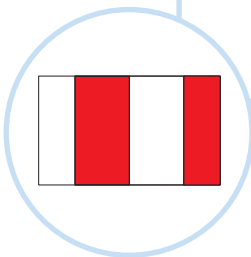
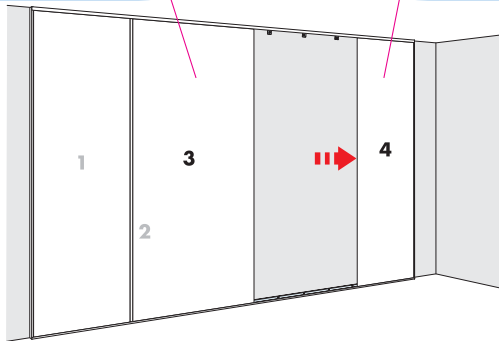

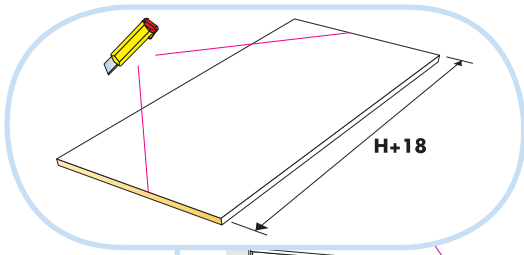

7

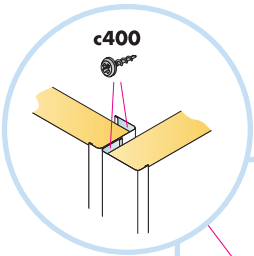
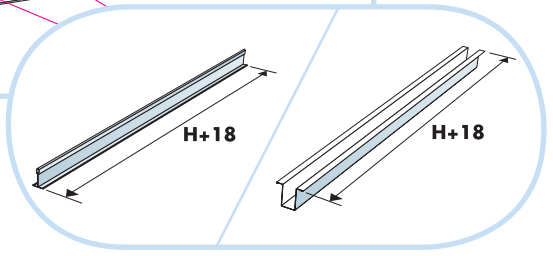
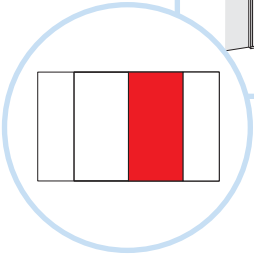
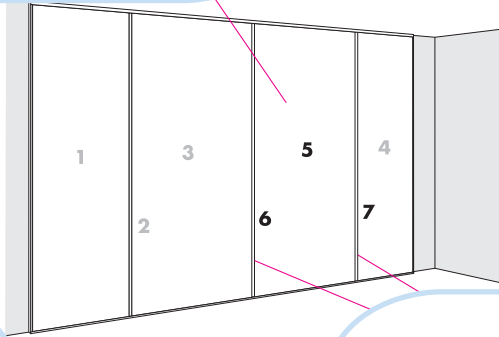

8

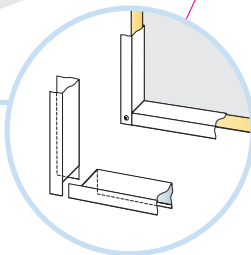
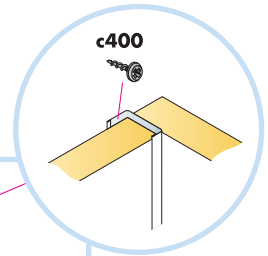
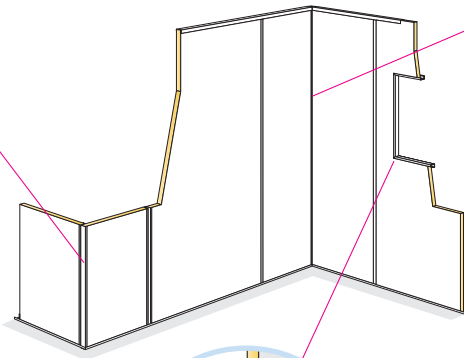

**Impact
Resistance**

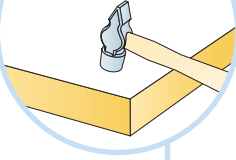

9

