



Ecophon Hygiene Performance™ Wall

Ecophon Hygiene Performance™ Wall is an easy to clean, sound absorbing wall panel system suitable for humid areas. The panels withstand advanced cleaning, such as steam and high/low pressure washing on a regular basis.



TAYS kitchen, Tampere, Finland

SYSTEM RANGE

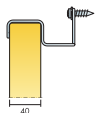

Size, mm	1200x600
Special	•
Thickness (THK)	40
Inst. Diag.	M467

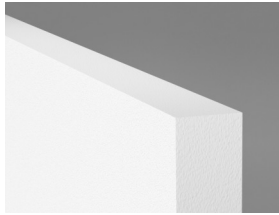

Hygiene Performance Wall

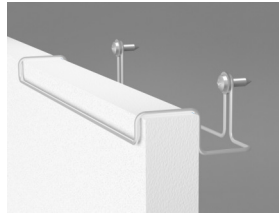

Connect Wall Fixing C3



Hygiene Performance Wall C3 system

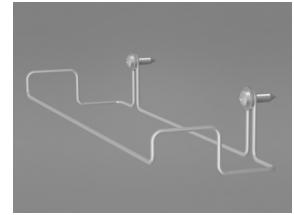

Connect Wall Fixing C3



Acoustic

Sound Absorption:

Test results according to EN ISO 354. Classification according to EN ISO 11654.

α_p , Practical sound absorption coefficient

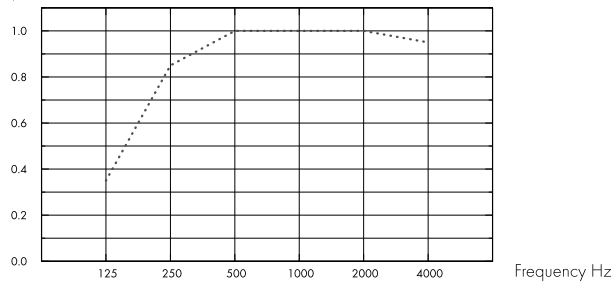

.... Hygiene Performance Wall, 80 mm o.d.s.

THK mm	o.d.s. mm	α_p , Practical sound absorption coefficient						α_w	Sound absorption class
		125 Hz	250 Hz	500 Hz	1000 Hz	2000 Hz	4000 Hz		
40	80	0.35	0.85	1.00	1.00	1.00	0.95	1.00	A



Indoor Air Quality

Certificate / Label

Eurofins Indoor Air Comfort®

IAC

French VOC

A

Finnish M1

•



Environmental Footprint

Kg CO₂ equiv/m²: 7,1 From family EPD in conformity with ISO 14025 / EN 15804



Circularity

Minimum post-consumer recycled content

54%

Recyclability

Fully recyclable



Fire safety

Country	Standard	Class
Europe	EN 13501-1	A2-s1,d0

The glass wool core of the tiles is tested and classified as non-combustible according to EN ISO 1182.



Humidity Resistance

Class C, relative humidity 95% and 30°C, according to EN 13964:2014



Visual appearance

White 500, nearest NCS colour sample S 0500-N, 84% light reflectance.



Cleanability

Daily dusting and vacuum cleaning. Weekly wet wiping.



Advanced Cleanability

High and low pressure cleaning with water and steam cleaning. Withstand use of hydrogen peroxide vapor.



Surface Endurance

Product tested according to ISO 11998, and withstand 200 cycles.



Chemical resistance/Disinfection

Chemical	Active Substance	Concentration
Actichlor plus	NaDCC (Sodium Dichloroisocyanurate)	1%
LifeClean	Chlorine dioxide	Undiluted
Etanol	Etanol	70%
Chlorine	Sodium Hypochlorite solution	2,5%
Virkon S	Sulfamic acid	1%
Isopropanol	Isopropyl Alcohol	70%
Oxivir Excel	Hydrogen peroxide	0,5%
Sumabac D10	Quaternary ammonium compound, Sodium carbonate	1%
Suredis VT1	n-(3-aminopropyl)-n-dodecylpropan-1,3-diamin	1%
Enduro Chlor VE5	Potassium hydroxide	1,5%
Aciplusfoam VF59	Nitric Acid	5%

Tested according to ISO 11998 and withstand the following chemicals or disinfectants.



Mould and Bacterial Resistance

Standard/Method	
ISO 846 A	0
ISO 846 C	0



Clean Room

Standard	Standard/Method	Class
ISO 14644	Particle cleanliness class	ISO 4
NF S 90-351	Microbiological class	M1/area 4
NF S 90-351	Particle elimination kinetics	CP(0,5) 5



Accessibility

The tiles are demountable.



Installation

Installed according to installation diagrams, installation guides and drawing aid. For information regarding minimum overall depth of system see quantity specification.



System weight

The weight of the system (including profile system) should be approximately 3 kg/pcs.



Mechanical properties

See table about Max live load and Min load bearing capacity and Functional demands, Mechanical properties at www.ecophon.com.

INSTALLATION DIAGRAM (M467) FOR ECOPHON HYGIENE PERFORMANCE™ WALL C3

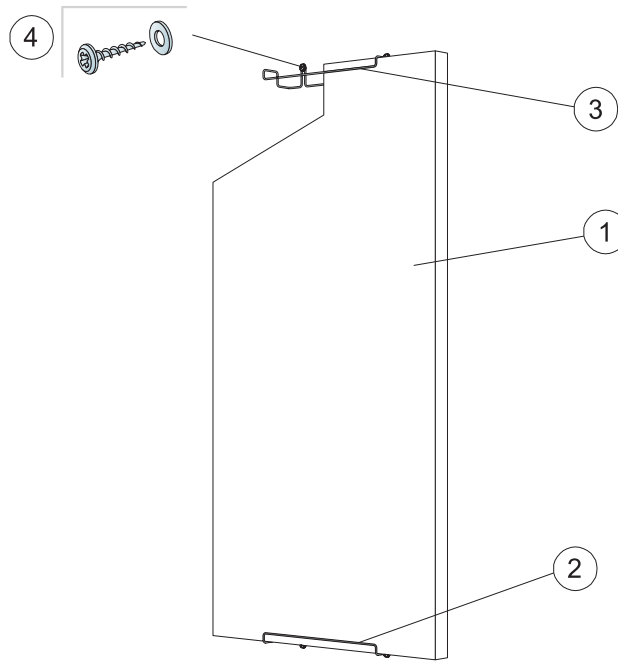

© Ecophon Group

QUANTITY SPECIFICATION (EXCL. WASTAGE)

		Size, mm
		1200x600
1	Hygiene Performance Wall	1,4/m ²
2	Connect Wall Fixing C3, vertical installation	2/panel
3	Connect Wall Fixing C3, horizontal installation	4/panel
4	Wall screw, A2 material (not supplied by Ecophon)	2/wall fixing
Δ Min. overall depth of system: 90 mm		-

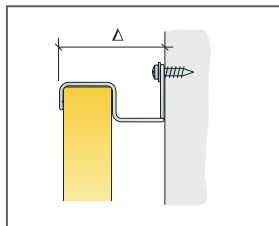

See Quantity Specification

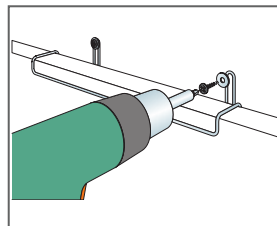

Installation with wall screw in stainless steel (A2) material

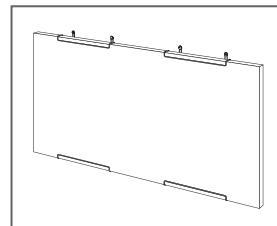

Horizontal installation of Performance Wall C3