

Ecophon Super G™ A

Ecophon Super G™ A has an exposed grid system with impact bracing bars or clips to keep tiles in place. For applications in school corridors and other environments where there is a risk for mechanical impact.



Cardea, Leiderdorp, Netherlands

SYSTEM RANGE

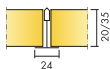

Size, mm	600x600	600x600	1200x600	1200x600
T24	•	•	•	•
Thickness (THK)	20	35	20	35
Inst. Diag.	M199	M55	M199	M55

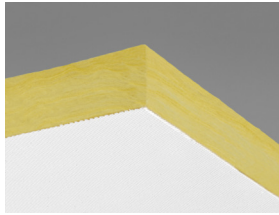

Super G A tile

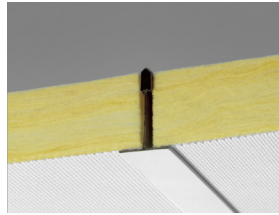

Section of Super G A system with Connect T24



Super G A system

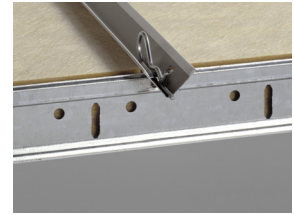

Super G A with Connect Impact bracing



Acoustic

Sound Absorption:

Test results according to EN ISO 354. Classification according to EN ISO 11654, and the single value ratings for Noise Reduction Coefficient, NRC and Sound Absorption Average, SAA according to ASTM C 423.

α_p , Practical sound absorption coefficient

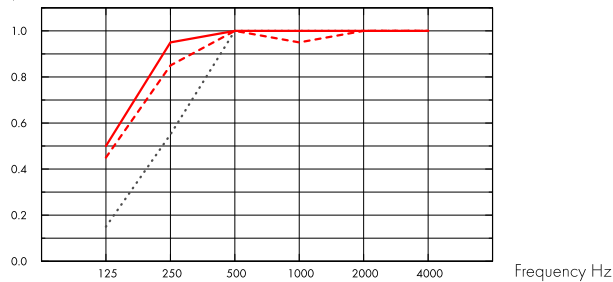

- Super G A 20 mm, 200 mm o.d.s.
- Super G A 35 mm, 50 mm o.d.s.
- Super G A 35 mm, 200 mm o.d.s.

THK mm	o.d.s. mm	α_p , Practical sound absorption coefficient						α_w	Sound absorption class
		125 Hz	250 Hz	500 Hz	1000 Hz	2000 Hz	4000 Hz		
20	200	0.45	0.85	1.00	0.95	1.00	1.00	1.00	A
35	50	0.15	0.55	1.00	1.00	1.00	1.00	0.85	B
35	200	0.50	0.95	1.00	1.00	1.00	1.00	1.00	A

THK mm	o.d.s. mm	NRC	SAA
35	50	0.90	0.92
35	200	1.00	0.97
35	400	0.90	0.92



Indoor Air Quality

Certificate / Label	
Eurofins Indoor Air Comfort®	IAC
French VOC	A
Finnish M1	•



Environmental Footprint

Kg CO ₂ equiv/m ²	
Super G A 20mm	3,28 (Super G family EPD in conformity with ISO 14025 / EN 15804)
Super G A 35mm	4,90 (Super G EPD in conformity with ISO 14025 / EN 15804)



Circularity

Minimum post-consumer recycled content (35 mm Super GA)	51%
Minimum post-consumer recycled content (20 mm Super GA)	42%
Recyclability	Fully recyclable



Fire safety

Country	Standard	Class
Europe	EN 13501-1	A2-s1,d0

The glass wool core of the tiles is tested and classified as non-combustible according to EN ISO 1182.



Humidity Resistance

Class C, relative humidity 95% and 30°C, according to EN 13964:2014



Visual appearance

White 085. Nearest NCS colour sample: S 1002-Y. Light reflectance: 78%. (The tiles need to be installed in accordance with the arrows on the back of the tile in order to get optimal visual appearance).



Cleanability

Daily dusting and vacuum cleaning. Weekly wet wiping.



Accessibility

The tiles are not demountable.



Installation

Installed according to installation diagrams, installation guides and drawing aid. (The tiles have to be installed according to the arrows on the back of the tile.)



System weight

The weight of the system (including suspension grid) should be approximately 3-4 kg/m²



Mechanical properties

See table regarding the min- and max- load bearing capacities and functional demands.



Impact Resistance

Thickness	M-sketch	
20	M199	3A
35	M55	2A

Tested and classified according to EN 13964 annex D.



CE

Ecophon ceiling systems are CE marked according to the European harmonized standard EN 13964:2014. CE marked construction products are covered by a Declaration of Performance (DOP) which enables customers and users to easily compare performance of products available on the European market.

INSTALLATION DIAGRAM (M199) FOR ECOPHON SUPER G A (20MM)

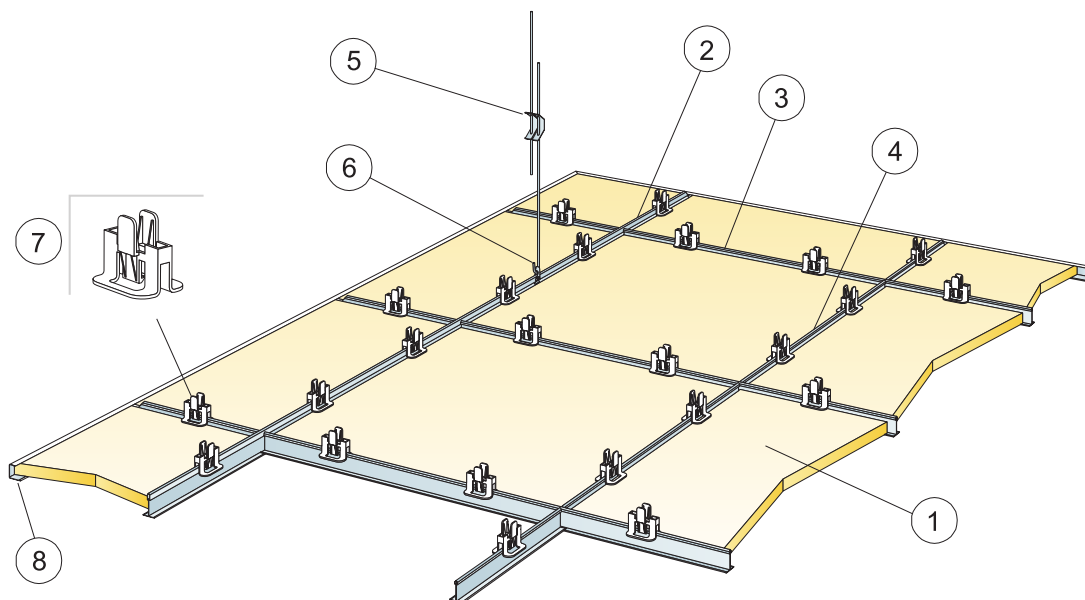

© Ecophon Group

QUANTITY SPECIFICATION (EXCL. WASTAGE)

	Size, mm	
	600x600	1200x600
1 Super G A	2,8/m ²	1,4/m ²
2 Connect T24 Main runner, installed at 1200 mm centres (max distance from wall 300 mm)	0,9m/m ²	0,9m/m ²
3 Connect T24 Cross tee, L=1200 mm, installed at 600 mm centres	1,7m/m ²	1,7m/m ²
4 Connect T24 Cross tee, L=600 mm	0,9m/m ²	-
5 Connect Adjustable Hanger, installed at 1200 mm centres (max. distance from wall 600 mm)	0,7/m ²	0,7/m ²
6 Connect Hanger clip (secured with screw)	0,7/m ²	0,7/m ²
7 Connect Hygiene Clip 20	11/m ²	7/m ²
8 Connect Channel trim	as required	as required
Δ Min. overall depth of system: 150 mm	-	-
δ Min. demounting depth: 150 mm (non-clipped panel)	-	-

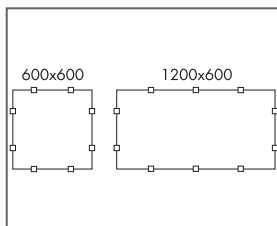
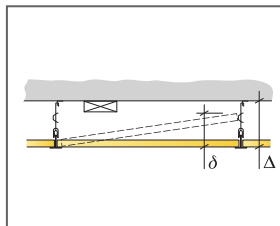

Arrangement of clips

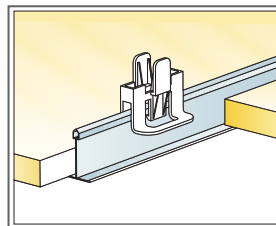

Clip for keeping tiles in place

Size, mm	Max live load (N)	Min load bearing capacity (N)
600x600	50	160
1200x600	50	160

Live load/load bearing capacity

INSTALLATION DIAGRAM (M55) FOR ECOPHON SUPER G A AND SUPER G A XL, SUSPENDED INSTALLATION (35MM)

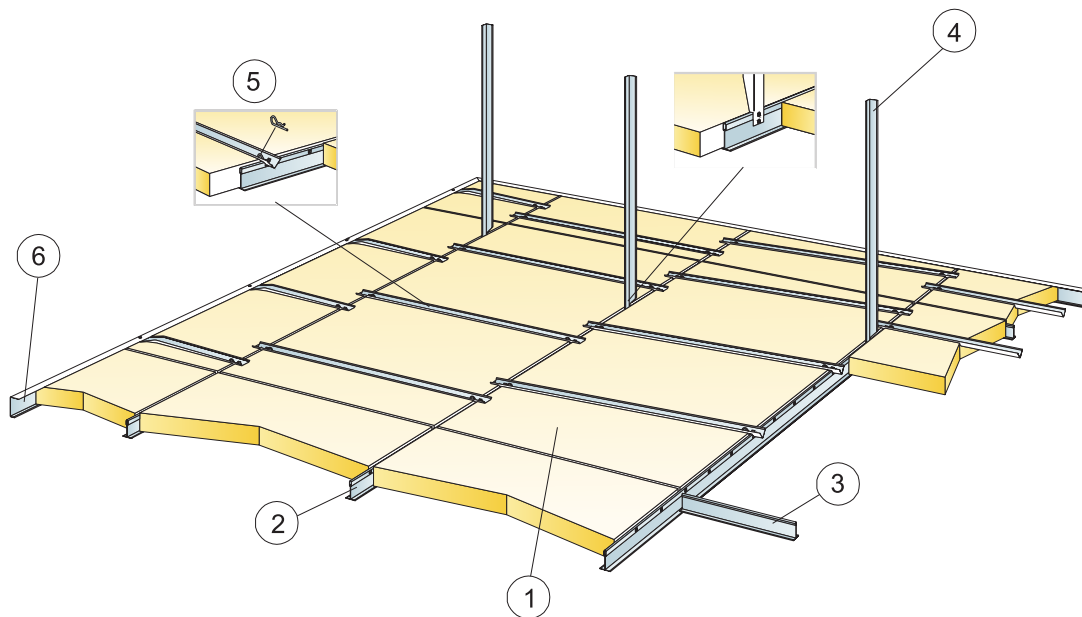

© Ecophon Group

QUANTITY SPECIFICATION (EXCL. WASTAGE)

	Size, mm	
	600x600	1200x600
1 Super G A and Super G A XL	2,8/m ²	1,4/m ²
2 Connect T24 Main runner, installed at 600 mm centres	1,7m/m ²	1,7m/m ²
3 Connect T24 Cross tee, L=600 mm	1,7m/m ²	0,9m/m ²
4 Rigid hanger made of Connect Angle trim, max. L=1200 mm at 1200 mm centres	1,4/m ²	1,4/m ²
5 Connect Impact Bracing (Split pins included)	5,6/m ²	4,2/m ²
6 Connect Channel trim, fixed at 300 mm centres (h=44 mm)	as required	as required
Δ Min. overall depth of system: 200 mm	-	-
δ Min. demounting depth: 200 mm (for tile without Impact bracing)	-	-

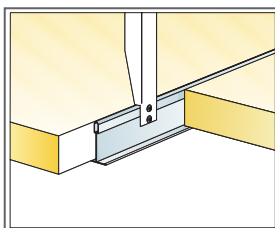
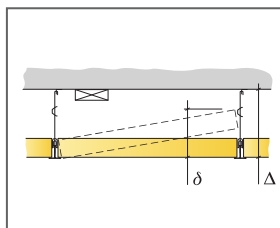

Detail of suspension

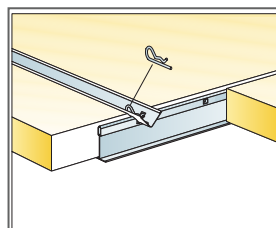

Connection between profiles with split pin

Size, mm	Max live load (N)	Min load bearing capacity (N)
600x600	40	160
1200x600	40	160

Live load/load bearing capacity