

Ecophon Hygiene Advance™ Wall

Ecophon Hygiene Advance™ Wall is a wall panel that withstands daily advanced cleaning and disinfection with strong chemicals. Suitable for the most demanding conditions, including airborne grease and dirt particles.



Easyfood, Kolding, Denmark

SYSTEM RANGE

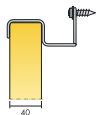

Size, mm	1200x600
Special	•
Thickness (THK)	40
Inst. Diag.	M258



Hygiene Advance Wall



Connect Wall fixing C3

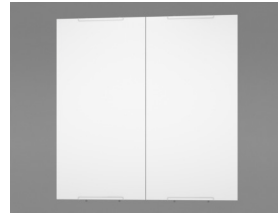

Hygiene Advance Wall C3 system

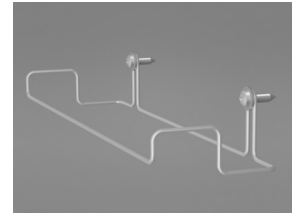

Connect Wall Fixing C3



Acoustic

Sound Absorption:

Test results according to EN ISO 354. Classification according to EN ISO 11654.

α_p , Practical sound absorption coefficient

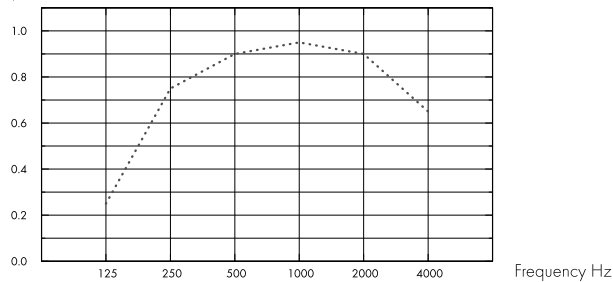

..... Hygiene Advance Wall, 80 mm o.d.s.

THK mm	o.d.s. mm	α_p , Practical sound absorption coefficient						α_w	Sound absorption class
		125 Hz	250 Hz	500 Hz	1000 Hz	2000 Hz	4000 Hz		
40	80	0.25	0.75	0.90	0.95	0.90	0.65	0.85	B



Indoor Air Quality

Certificate / Label

Eurofins Indoor Air Comfort®

IAC Gold

French VOC

A+

Finnish M1

•



Circularity

Minimum post-consumer recycled content

64%

Recyclability

Fully recyclable



Fire safety

Country

Standard

Class

Europe

EN 13501-1

A2-s1,d0

The glass wool core of the tiles is tested and classified as non-combustible according to EN ISO 1182.



Humidity Resistance

Class C, relative humidity 95% and 30°C, according to EN 13964:2014



Visual appearance

White 141, nearest NCS colour sample S 1000-N, 73% light reflectance.



Cleanability

Daily dusting, vacuum cleaning and wet wiping.



Advanced Cleanability

High and low pressure cleaning with water and steam cleaning. Withstand use of hydrogen peroxide vapor.



Chemical resistance/Disinfection

Chemical	Concentration
Formalin	37%
Ammoniac	25%
Hydrogen peroxide	30%
Sulfuric acid	5%
Phosphoric acid	30%
Peracetic acid	15%
Hydrochloric acid	5%
Isopropanol	100%
Sodium hydroxide	5%
Sodium hypochlorite	5%

Tested according to ISO 2812-1 and classified according to ISO 4628-1 with excellent result for the following chemicals.



Mould and Bacterial Resistance

Standard/Method	
ISO 846 A	1
ISO 846 C	0



Clean Room

Standard	Standard/Method	Class
ISO 14644	Particle cleanliness class	ISO 3
NF S 90-351	Microbiological class	M1/area 4
NF S 90-351	Particle elimination kinetics	CP(0,5) 1



Accessibility

The tiles are demountable.



Installation

Installed according to installation diagrams, installation guides and drawing aid. For information regarding minimum overall depth of system see quantity specification.



System weight

The weight of the system (including profile system) should be approximately 3 kg/pcs.



Mechanical properties

See table about Max live load and Min load bearing capacity and Functional demands, Mechanical properties at www.ecophon.com.



CE

Ecophon ceiling systems are CE marked according to the European harmonized standard EN 13964:2014. CE marked construction products are covered by a Declaration of Performance (DOP) which enables customers and users to easily compare performance of products available on the European market.

INSTALLATION DIAGRAM (M258) FOR ECOPHON HYGIENE ADVANCE™ WALL C3

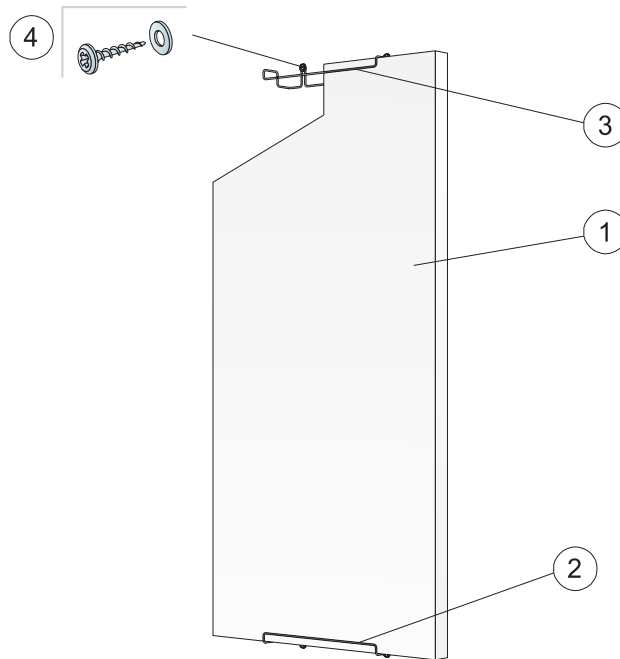

© Ecophon Group

QUANTITY SPECIFICATION (EXCL. WASTAGE)

		Size, mm
		1200x600
1	Hygiene Advance Wall	1,4/m ²
2	Connect Wall Fixing C3, vertical installation	2/panel
3	Connect Wall Fixing C3, horizontal installation	4/panel
4	Wall screw, A2 material (not supplied by Ecophon)	2/wall fixing
Δ Min. overall depth of system: 90 mm		-

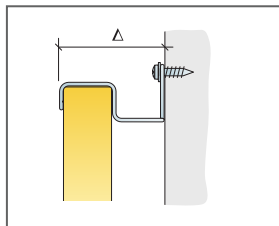

See Quantity Specification

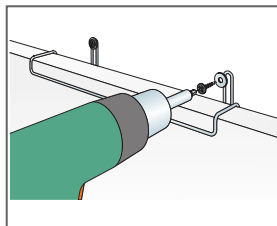

Installation with wall screw in stainless steel (A2) material

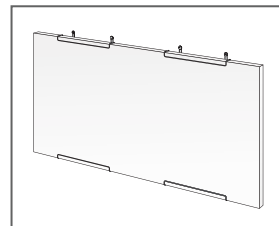

Horizontal installation of Advance Wall C3