



Ecophon Combison™ A, dB 42

Ecophon Combison™ dB is the fastest and easiest way to combine features for both sound absorption and sound insulation between rooms. Ideal for installations where the partitions do not extend all the way up to the soffit. Combison dB can also help to reduce vertical noise from floor to floor. The panel is easy to handle, install and demount and it has a visible grid system. It is made from crimped glass fibre and has an Akutex FT surface on the front.



SYSTEM RANGE

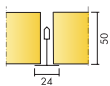

Size, mm	600x600	1200x600
T24	•	•
Thickness (THK)	50	50
Inst. Diagr.	M531	M531

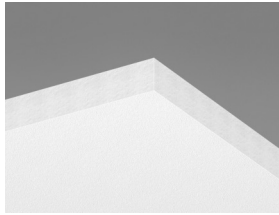

Combison A dB 42 tile

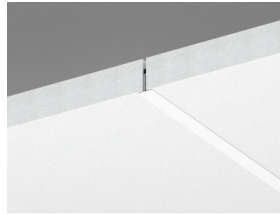

Section of Combison A dB 42 system



Combison A dB 42 system

Acoustic



Sound Absorption:

Test results according to EN ISO 354. Classification according to EN ISO 11654.

α_p , Practical sound absorption coefficient

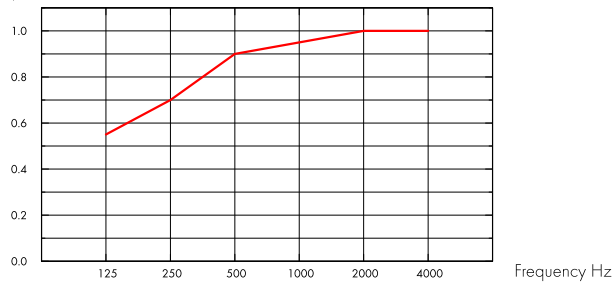

— Combison dB 42 A/E, 200 mm o.d.s.
o.d.s. = overall depth of system

THK mm	o.d.s. mm	α_p , Practical sound absorption coefficient						α_w	Sound absorption class
		125 Hz	250 Hz	500 Hz	1000 Hz	2000 Hz	4000 Hz		
50	200	0.55	0.70	0.90	0.95	1.00	1.00	0.95	A

THK mm	o.d.s. mm	NRC	SAA
50	200	0.90	0.90

THK mm	Product	D_{nfw}	R_w
		Weighted normalized flanking level difference, ISO 10848-2	Weighted sound reduction index, ISO 10140-2
50	-	42	21
-	+ 1 x Barrier	+4	-
-	+ 2 x Barrier	+8	-
-	+ 2 x 1200 XR	+3	-

Indoor Air Quality



Certificate / Label	All Products
Eurofins Indoor Air Comfort®	IAC Gold
French VOC	A+
Finnish M1	•



Environmental Footprint



	kg CO ₂ equiv/m ²
Combison A dB 42	8,0

Life-cycle stages A1 to C4 from EPD, in conformity with ISO 14025 / EN 15804



Circularity

Fully recyclable.



Fire safety

Country	Fire standard	Class
Europe	EN 13501-1	A2-s1,d0

The glass wool core of the tiles is tested and classified as non-combustible according to EN ISO 1182.



Humidity Resistance

Class A, relative humidity 70% and 25°C, according to EN 13964:2014



Visual appearance

Akutex FT: White Frost, nearest NCS colour sample S 0500-N, 85% light reflectance. Gloss < 1. For more info see Colours and surfaces.



Cleanability

Akutex FT: Daily dusting and vacuum cleaning. Weekly wet wiping. For more info see Colours and surfaces.



Accessibility

The tiles are easily demountable. Minimum demounting depth according to installation diagrams.



Installation

Installed according to installation diagrams, installation guides and drawing aid. For information regarding minimum overall depth of system see quantity specification.



System weight

	kg/m ²
Combison A, dB 42	6,8
Combison A, dB 42 + Connect Grid System	7,8

Weight information is indicative and subject to variation.



Mechanical properties

See table about Max live load and Min load bearing capacity and Functional demands, Mechanical properties at www.ecophon.com.



CE

Ecophon ceiling systems are CE marked according to the European harmonized standard EN 13964:2014. CE marked construction products are covered by a Declaration of Performance (DOP) which enables customers and users to easily compare performance of products available on the European market.

INSTALLATION DIAGRAM (M531) FOR ECOPHON COMBISON A, DB 42

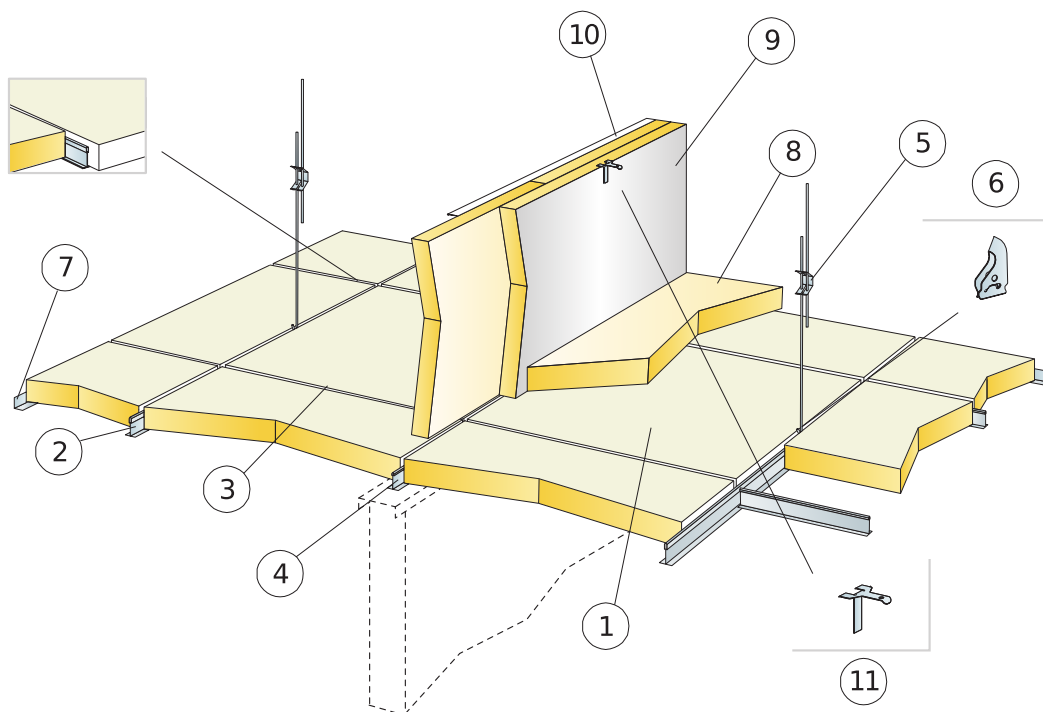

QUANTITY SPECIFICATION (EXCL. WASTAGE)

	Size, mm	
	600x600	1200x600
1 Combison A, dB 42	2,8/m ²	1,4/m ²
2 Connect T24 Main runner, installed at 1200 mm centres (max distance from wall 300 mm)	0,9m/m ²	0,9m/m ²
3 Connect T24 Cross tee, L=1200 mm, installed at 600 mm centres	1,7m/m ²	1,7m/m ²
4 Connect T24 Cross tee, L=600 mm	0,9m/m ²	-
5 Connect Adjustable Hanger, installed at 1200 mm centres (max. distance from wall 600 mm)	0,7/m ²	0,7/m ²
6 Connect Hanger Clip (not to be used in swimming hall environments)	0,7/m ²	0,7/m ²
7 Connect Angle trim, fixed at 200 mm centres	as required	as required
8 Combison XR (if required)	as required	as required
9 Combison Barrier (if required)	as required	as required
10 Connect Angle trims position upper part of Barrier panels (if required)	as required	as required
11 Connect Frieze bracket, position upper part of Barrier panels (if required)	as required	as required
Δ Min. overall depth of system: 100 mm	-	-
δ Min. demounting depth: 210 mm	-	-

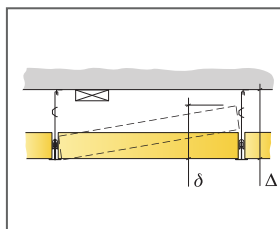

See Quantity specification

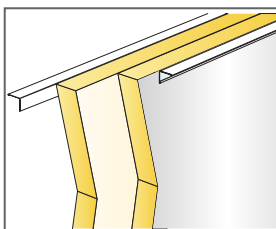

Si il y a deux barrières, la feuille alu doit être à l'extérieur

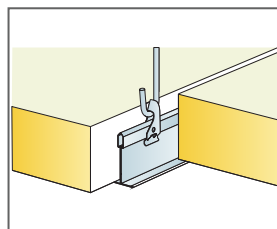

Suspension with adjustable hanger and clip

Size, mm	Max live load (N)	Min load bearing capacity (N)
600x600x50	15	160
1200x600x50	15	160

Live load/load bearing capacity

Ecophon Combison™ Uno A

Ecophon Combison™ Uno A has an exposed grid system with demountable tiles. For use as a sound absorbing ceiling and for sound insulation between rooms if the partitions does not extend all the way up to the soffit. Also suitable for sound reduction of vertical noise.

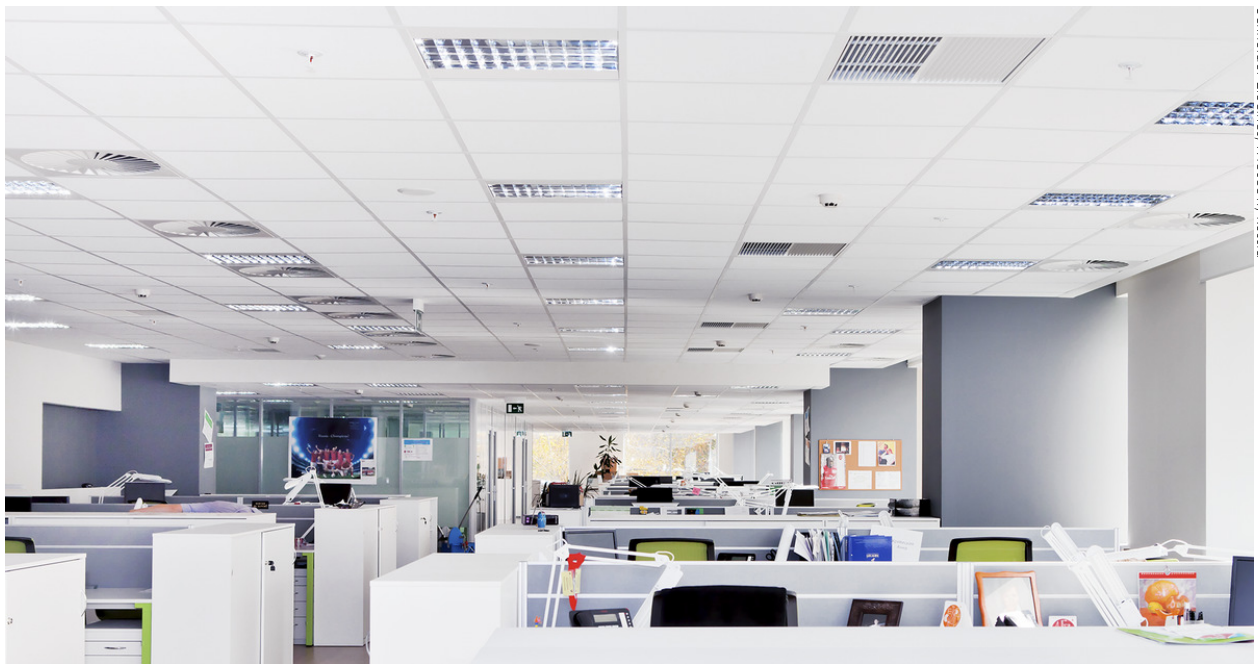

Schneider Electric, Moscow, Russia

SYSTEM RANGE

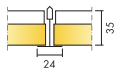

Size, mm	600x600	1200x600
T24	•	•
Thickness (THK)	35	35
Inst. Diag.	M188	M188

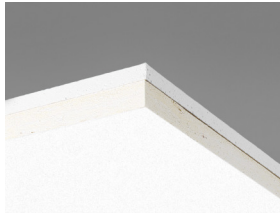

Combison Uno A tile

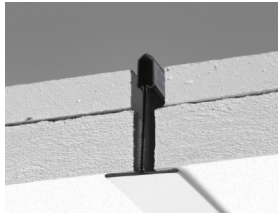

Section of Combison Uno A system

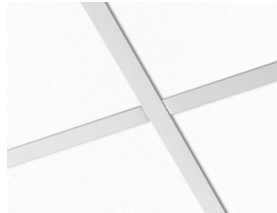

Combison Uno A system

Acoustic



Sound Absorption:

Test results according to EN ISO 354. Classification according to EN ISO 11654, and the single value ratings for Noise Reduction Coefficient, NRC and Sound Absorption Average, SAA according to ASTM C 423.

α_p , Practical sound absorption coefficient

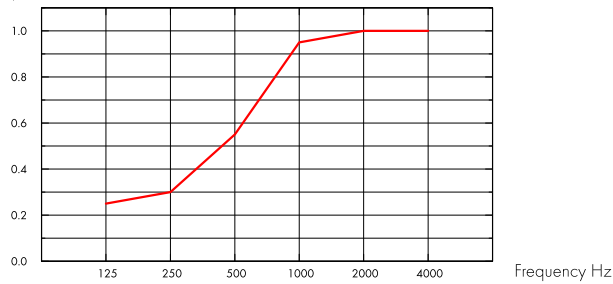

— Combison Uno A 35 mm, 200 mm o.d.s.
o.d.s = overall depth of system

THK mm	o.d.s. mm	α_p , Practical sound absorption coefficient						α_w	Sound absorption class
		125 Hz	250 Hz	500 Hz	1000 Hz	2000 Hz	4000 Hz		
35	200	0.25	0.30	0.55	0.95	1.00	1.00	0.55	D

THK mm	o.d.s. mm	NRC	SAA
35	200	0.70	0.73

THK mm	D_{nfw} Weighted normalized flanking level difference, ISO 10848-2	R_w Weighted sound reduction index, ISO 10140-2	CAC dB Ceiling Attenuation Class, ASTM 1414, ASTM E413
35	43	27	44

Indoor Air Quality



Certificate / Label	
French VOC	A
Finnish M1	•



Circularity



Minimum post-consumer recycled content	56%*
Recyclability	Fully recyclable

*this value does not take into account the plasterboard



Fire safety

Country	Fire standard	Class
Europe	EN 13501-1	A2-s1,d0

The glass wool core of the tiles is tested and classified as non-combustible according to EN ISO 1182.



Humidity Resistance

Class A, relative humidity 70% and 25°C, according to EN 13964:2014



Visual appearance

White Frost, nearest NCS colour sample S 0500-N, 85% light reflectance. Gloss < 1.



Cleanability

Daily dusting and vacuum cleaning. Weekly wet wiping.



Accessibility

The tiles are easily demountable. Minimum demounting depth according to installation diagrams.



Installation

Installed according to installation diagrams, installation guides and drawing aid. For information regarding minimum overall depth of system see quantity specification.



System weight

	kg/m ²
Combison Uno A	11,0
Combison Uno A + Connect Grid System	12,0

Weight information is indicative and subject to variation.



Mechanical properties

See table about Max live load and Min load bearing capacity and Functional demands, Mechanical properties at www.ecophon.com.



CE

Ecophon ceiling systems are CE marked according to the European harmonized standard EN 13964:2014. CE marked construction products are covered by a Declaration of Performance (DOP) which enables customers and users to easily compare performance of products available on the European market.

INSTALLATION DIAGRAM (M188) FOR ECOPHON COMBISON UNO A

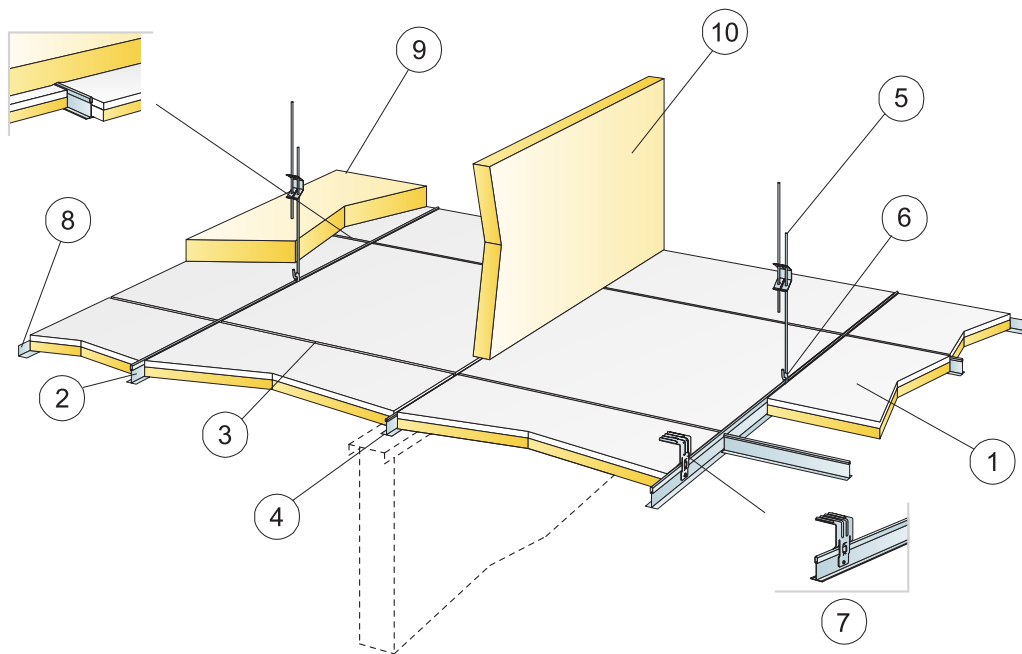

© Ecophon Group

QUANTITY SPECIFICATION (EXCL. WASTAGE)

		Size, mm	
		600x600	1200x600
1	Combison Uno A	2,8/m ²	1,4/m ²
2	Connect T24 Main runner, installed at 1200 mm centres (max distance from wall 300 mm)	0,9m/m ²	0,9m/m ²
3	Connect T24 Cross tee, L=1200 mm, installed at 600 mm centres	1,7m/m ²	1,7m/m ²
4	Connect T24 Cross tee, L=600 mm	0,9m/m ²	-
5	Connect Adjustable Hanger, installed at 1200 mm centres (max. distance from wall 600 mm)	0,7/m ²	0,7/m ²
6	Connect Hanger Clip (not to be used in swimming hall environments)	0,7/m ²	0,7/m ²
7	For direct installation: Connect Direct Bracket, installed at 1200 mm centres	0,7/m ²	0,7/m ²
8	Connect Angle trim, fixed at 200 mm centres	as required	as required
9	Combison XR (if required)	as required	as required
10	Combison Barrier (if required)	as required	as required
Δ Min. overall depth of system, with adjustable hanger: 100 mm, with direct bracket: 50 mm		-	-
δ Min. demounting depth: 200 mm		-	-

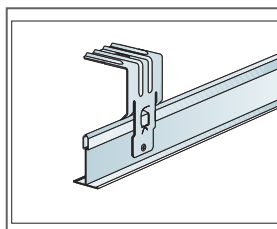
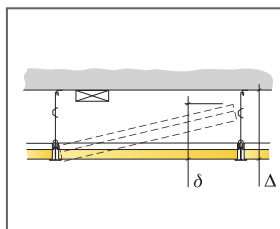

Direct bracket is secured with pop rivet or screw

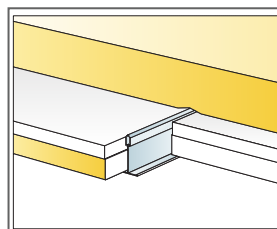

Additional absorber on top of ceiling

Size, mm	Max live load (N)	Min load bearing capacity (N)
600x600x35	0	220
1200x600x35	0	220

Live load/load bearing capacity

Ecophon Combison™ Uno Ds

Ecophon Combison™ Uno Ds has a concealed grid, installed in a suspended grid system with demountable tiles. For use as a sound absorbing ceiling and for sound insulation between rooms if the partitions do not extend all the way up to the soffit. Also suitable for sound reduction of vertical noise.



Altherton leisure, London, United Kingdom

SYSTEM RANGE

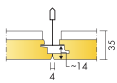

Size, mm	600x600
T24	•
Thickness (THK)	35
Inst. Diag.	M629



Combison Uno Ds tile

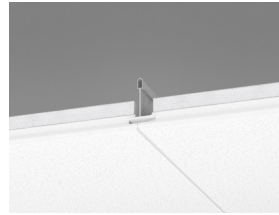

Section of Combison Uno Ds system with Connect T24

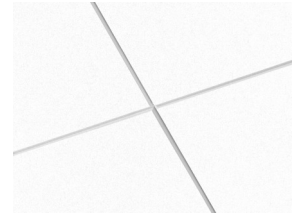

Combison Uno Ds system

Acoustic



Sound Absorption:

Test results according to EN ISO 354. Classification according to EN ISO 11654, and the single value ratings for Noise Reduction Coefficient, NRC and Sound Absorption Average, SAA according to ASTM C 423.

α_p , Practical sound absorption coefficient

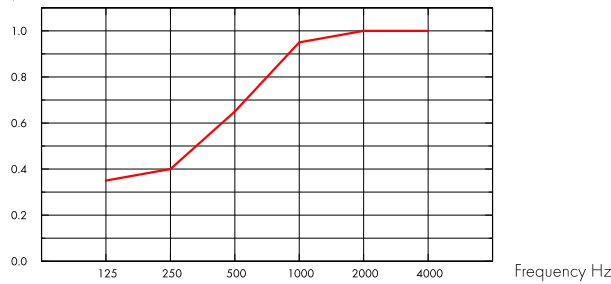

— Combison Uno Ds 35 mm, 200 mm o.d.s.
o.d.s = overall depth of system

THK mm	o.d.s. mm	α_p , Practical sound absorption coefficient						α_w	Sound absorption class
		125 Hz	250 Hz	500 Hz	1000 Hz	2000 Hz	4000 Hz		
35	200	0.35	0.40	0.65	0.95	1.00	1.00	0.65	C

THK mm	o.d.s. mm	NRC	SAA
35	200	0.75	0.75

THK mm	D_{nfw}		R_w
	Weighted normalized flanking level difference, ISO 10848-2		Weighted sound reduction index, ISO 10140-2
30	41		28

Indoor Air Quality



Certificate / Label	
French VOC	A
Finnish M1	•



Circularity



Minimum post-consumer recycled content	56%*
Recyclability	Fully recyclable

*this value does not take into account the plasterboard

Fire safety



Country	Fire standard	Class
Europe	EN 13501-1	A2-s1,d0

The glass wool core of the tiles is tested and classified as non-combustible according to EN ISO 1182.



Humidity Resistance

Class A, relative humidity 70% and 25°C, according to EN 13964:2014



Visual appearance

White Frost, nearest NCS colour sample S 0500-N, 85% light reflectance. Gloss < 1.



Cleanability

Daily dusting and vacuum cleaning. Weekly wet wiping.



Accessibility

The tiles are easily demountable. Minimum demounting depth according to installation diagrams.



Installation

Installed according to installation diagrams, installation guides and drawing aid. For information regarding minimum overall depth of system see quantity specification.



System weight

	kg/m ²	Weight information is indicative and subject to variation.
Combison Uno Ds	11,4	
Combison Uno Ds + Connect Grid System	12,4	



Mechanical properties

See table about Max live load and Min load bearing capacity and Functional demands, Mechanical properties at www.ecophon.com.



CE

Ecophon ceiling systems are CE marked according to the European harmonized standard EN13964:2014. CE marked construction products are covered by a Declaration of Performance (DOP) which enables customers and users to easily compare performance of products available on the European market.

INSTALLATION DIAGRAM (M629) FOR ECOPHON COMBISON UNO DS. SUSPENDED INSTALLATION

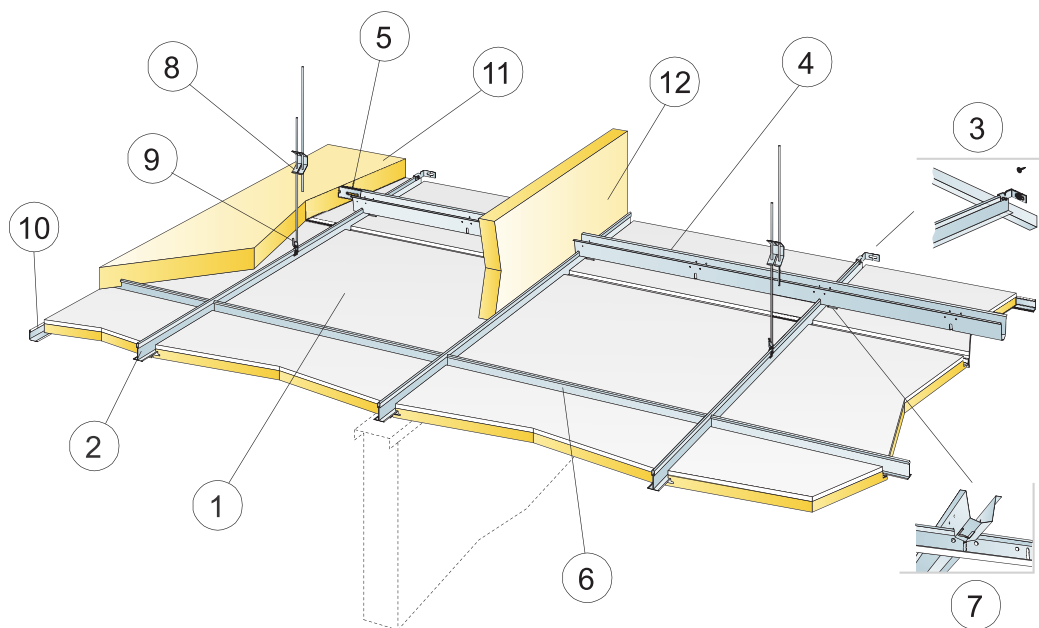

© Ecophon Group

QUANTITY SPECIFICATION (EXCL. WASTAGE)

	Size, mm
	600x600
1 Combison Uno Ds	2,8/m ²
2 Connect T24 Main Runner PL, installed at 600 mm centres	1,7m/m ²
3 Connect Wall Bracket for T-profiles	1/suspended row of Main runner
4 Connect Space Bar, installed at 900 mm centres (max. distance from wall 300 mm)	1,15m/m ²
5 Connect Wall Bracket, L=700 mm, for Connect Space Bar	1/row of Space bar
6 Connect T24 Cross Tee, L=600 mm	2/row of Main runner
7 Connect Space Bar Winch, installed one per joint Connect Main Runner/Connect Space Bar	1,9/m ²
8 Connect Adjustable Hanger, installed at 1200x900 mm (max. distance from wall 600 mm). Main Runners resting on partition walls don't need hangers.	0,95/m ²
9 Connect Hanger Clip (not to be used in swimming hall environments)	0,95/m ²
10 Connect Angle trim, fixed at 200 mm centres	as required
11 Combison XR (if required)	as required
12 Combison Barrier (if required)	as required
Δ Min. overall depth of system: 120 mm	-
δ Min. demounting depth: 40 mm	-

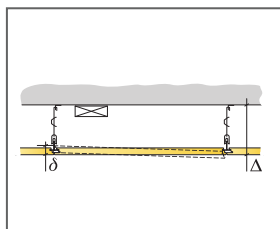

See Quantity Specification

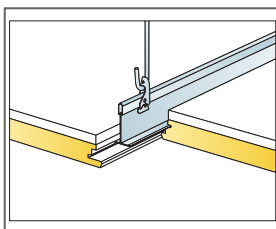

Suspension with adjustable hanger and clip

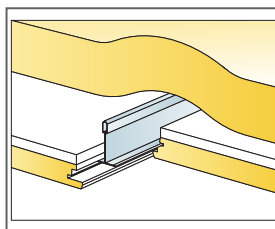

Additional absorber on top of ceiling

Size, mm	Max live load (N)	Min load bearing capacity (N)
600x600x35	0	220

Live load/load bearing capacity

Ecophon Combison™ Duo A

Ecophon Combison™ Duo A has an exposed grid system with demountable tiles. For use as a suspended ceiling with high sound absorption and for sound insulation between rooms if the partitions do not extend all the way up to the soffit. Also suitable for sound reduction of vertical noise.



SYSTEM RANGE

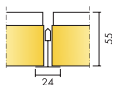

Size, mm	600x600
T24	•
Thickness (THK)	55
Inst. Diagr.	M85

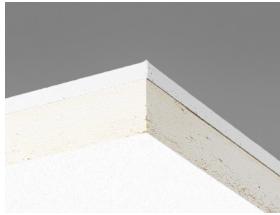

Combison Duo A tile

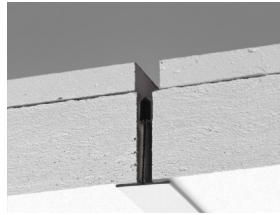

Section of Combison Duo A system

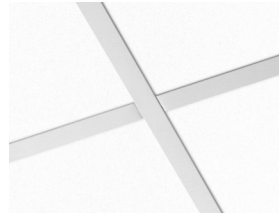

Combison Duo A system

Acoustic



Sound Absorption:

Test results according to EN ISO 354. Classification according to EN ISO 11654, and the single value ratings for Noise Reduction Coefficient, NRC and Sound Absorption Average, SAA according to ASTM C 423.

α_p , Practical sound absorption coefficient

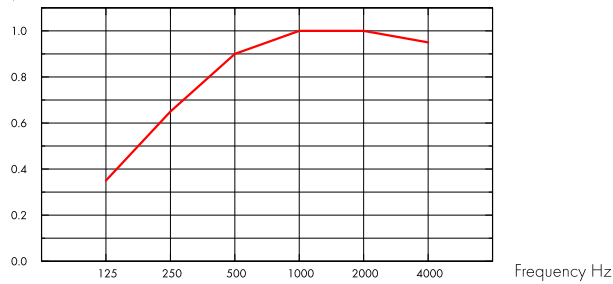

— Combison Duo A 54 mm, 200 mm o.d.s.
o.d.s = overall depth of system

THK mm	o.d.s. mm	α_p , Practical sound absorption coefficient						α_w	Sound absorption class
		125 Hz	250 Hz	500 Hz	1000 Hz	2000 Hz	4000 Hz		
54	200	0.35	0.65	0.90	1.00	1.00	0.95	0.90	A

THK mm	o.d.s. mm	NRC	SAA
54	400	0.90	0.90

THK mm	AC(1.5) Articulation Class, ASTM E1111, ASTM E1110	D_{nfw} Weighted normalized flanking level difference, ISO 10848-2	R_w Weighted sound reduction index, ISO 10140-2	CAC dB Ceiling Attenuation Class, ASTM 1414, ASTM E413
55	190	43	32	44

Indoor Air Quality



Certificate / Label	
French VOC	A
Finnish M1	•



Circularity



Minimum post-consumer recycled content	62%*
Recyclability	Fully recyclable

*this value does not take into account the plasterboard



Fire safety

Country	Fire standard	Class
Europe	EN 13501-1	A2-s1,d0

The glass wool core of the tiles is tested and classified as non-combustible according to EN ISO 1182.



Humidity Resistance

Class A, relative humidity 70% and 25°C, according to EN 13964:2014



Visual appearance

White Frost, nearest NCS colour sample S 0500-N, 85% light reflectance. Gloss < 1.



Cleanability

Daily dusting and vacuum cleaning. Weekly wet wiping.



Accessibility

The tiles are easily demountable. Minimum demounting depth according to installation diagrams.



Installation

Installed according to installation diagrams, installation guides and drawing aid. For information regarding minimum overall depth of system see quantity specification.



System weight

	kg/m ²
Combison Duo A	12,5
Combison Duo A + Connect Grid System	13,5

Weight information is indicative and subject to variation.



Mechanical properties

See table about Max live load and Min load bearing capacity and Functional demands, Mechanical properties at www.ecophon.com.



CE

Ecophon ceiling systems are CE marked according to the European harmonized standard EN 13964:2014. CE marked construction products are covered by a Declaration of Performance (DOP) which enables customers and users to easily compare performance of products available on the European market.

INSTALLATION DIAGRAM (M85) FOR ECOPHON COMBISON DUO A

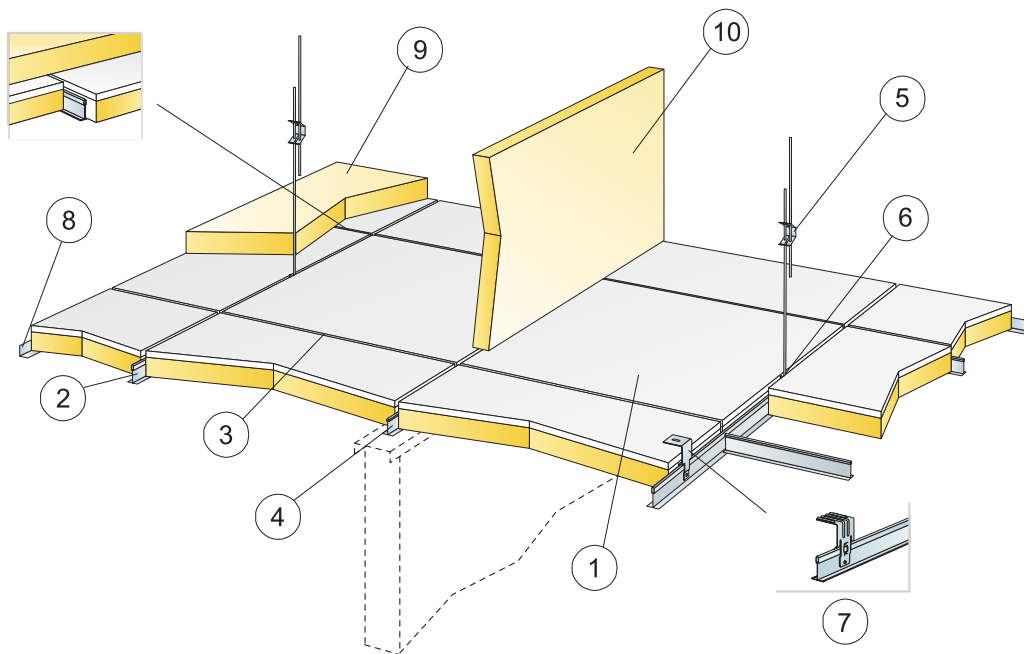

© Ecophon Group

QUANTITY SPECIFICATION (EXCL. WASTAGE)

		Size, mm
		600x600
1	Combison Duo A	2,8/m ²
2	Connect T24 Main runner, installed at 1200 mm centres (max distance from wall 300 mm)	0,9m/m ²
3	Connect T24 Cross tee, L=1200 mm, installed at 600 mm centres	1,7m/m ²
4	Connect T24 Cross tee, L=600 mm	0,9m/m ²
5	Connect Adjustable Hanger, installed at 1200 mm centres (max. distance from wall 600 mm)	0,7/m ²
6	Connect Hanger Clip (not to be used in swimming hall environments)	0,7/m ²
7	For direct installation: Connect Direct Bracket, installed at 1200 mm centres	0,7/m ²
8	Connect Angle trim, fixed at 200 mm centres	as required
9	Combison XR (if required)	as required
10	Combison Barrier (if required)	as required
Δ Min. overall depth of system, with Adjustable hanger: 100 mm, with Direct bracket: 80 mm		-
δ Min. demounting depth: 220 mm		-

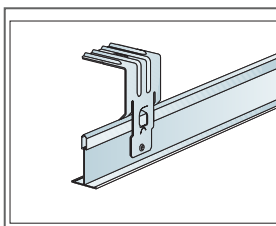
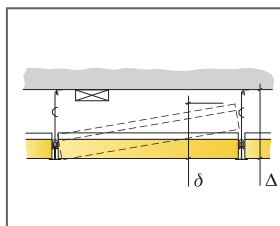

Direct bracket is secured with pop rivet or screw

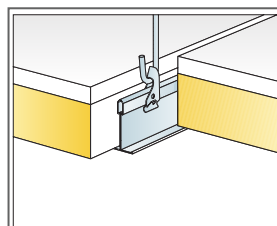

Suspension with adjustable hanger and clip

Size, mm	Max live load (N)	Min load bearing capacity (N)
600x600x55	0	220

Live load/load bearing capacity

Ecophon Combison™ Duo E

Ecophon Combison™ Duo E has a recessed visible grid and a tegular edge design, creating a ceiling with a shadow effect. For use as a suspended ceiling with high sound absorption and for sound insulation between rooms if the partitions do not extend all the way up to the soffit.



Statens Kulturråd, Stockholm, Sweden

SYSTEM RANGE

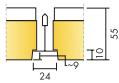

Size, mm	600x600
T24	•
Thickness (THK)	55
Inst. Diag.	M86

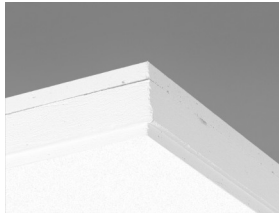

Combison Duo E tile

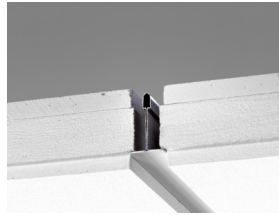

Section of Combison Duo E system

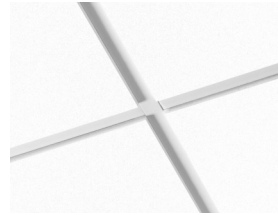

Combison Duo E system

Acoustic



Sound Absorption:

Test results according to EN ISO 354. Classification according to EN ISO 11654, and the single value ratings for Noise Reduction Coefficient, NRC and Sound Absorption Average, SAA according to ASTM C 423.

α_p , Practical sound absorption coefficient

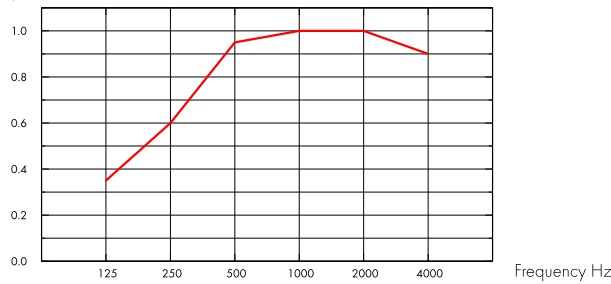

— Combison Duo E 54 mm, 200 mm o.d.s.
o.d.s = overall depth of system

THK mm	o.d.s. mm	α_p , Practical sound absorption coefficient						α_w	Sound absorption class
		125 Hz	250 Hz	500 Hz	1000 Hz	2000 Hz	4000 Hz		
54	200	0.35	0.60	0.95	1.00	1.00	0.90	0.90	A

THK mm	o.d.s. mm	NRC	SAA
54	400	0.90	0.89

THK mm	AC(1.5) Articulation Class, ASTM E1111, ASTM E1110	D_{nfw} Weighted normalized flanking level difference, ISO 10848-2	R_w Weighted sound reduction index, ISO 10140-2
55	190	39	33

Indoor Air Quality



Certificate / Label	
French VOC	A
Finnish M1	•



Circularity



Minimum post-consumer recycled content	61%*
Recyclability	Fully recyclable

*this value does not take into account the plasterboard



Fire safety

Country	Fire standard	Class
Europe	EN 13501-1	A2-s1,d0

The glass wool core of the tiles is tested and classified as non-combustible according to EN ISO 1182.



Humidity Resistance

Class A, relative humidity 70% and 25°C, according to EN 13964:2014



Visual appearance

White Frost, nearest NCS colour sample S 0500-N, 85% light reflectance. Gloss < 1.



Cleanability

Daily dusting and vacuum cleaning. Weekly wet wiping.



Accessibility

The tiles are easily demountable. Minimum demounting depth according to installation diagrams.



Installation

Installed according to installation diagrams, installation guides and drawing aid. For information regarding minimum overall depth of system see quantity specification.



System weight

	kg/m ²
Combison Duo E	12,6
Combison Duo E + Connect Grid System	13,6

Weight information is indicative and subject to variation.



Mechanical properties

See table about Max live load and Min load bearing capacity and Functional demands, Mechanical properties at www.ecophon.com.



CE

Ecophon ceiling systems are CE marked according to the European harmonized standard EN 13964:2014. CE marked construction products are covered by a Declaration of Performance (DOP) which enables customers and users to easily compare performance of products available on the European market.

INSTALLATION DIAGRAM (M86) FOR ECOPHON COMBISON DUO E

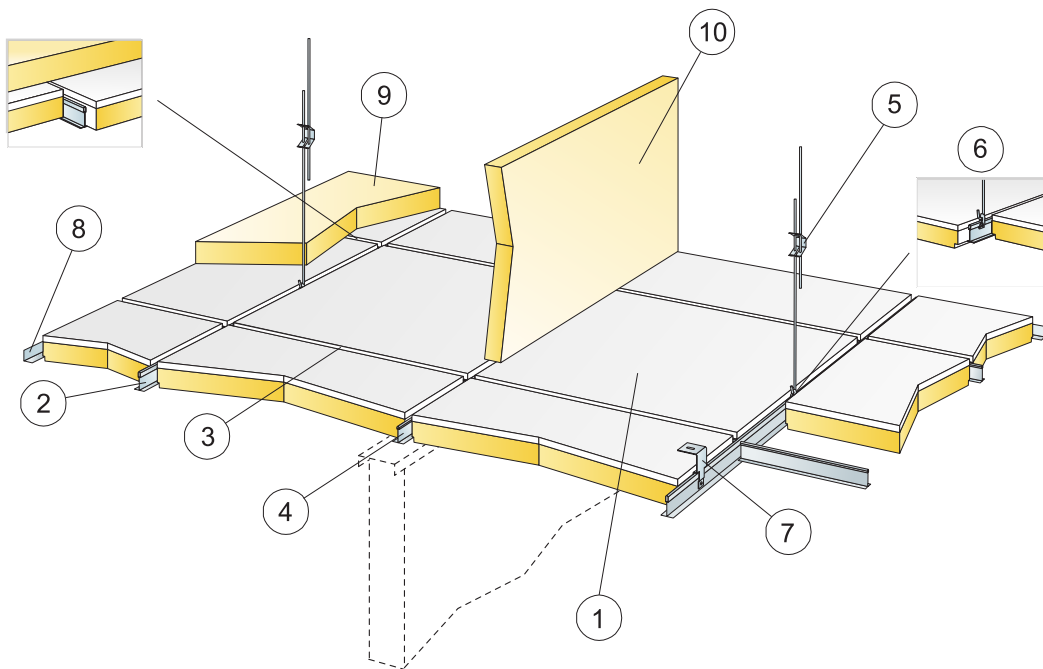

© Ecophon Group

QUANTITY SPECIFICATION (EXCL. WASTAGE)

		Size, mm
		600x600
1	Combison Duo E	2,8/m ²
2	Connect T24 Main runner, installed at 1200 mm centres (max distance from wall 300 mm)	0,9m/m ²
3	Connect T24 Cross tee, L=1200 mm, installed at 600 mm centres	1,7m/m ²
4	Connect T24 Cross tee, L=600 mm	0,9m/m ²
5	Connect Adjustable Hanger, installed at 1200 mm centres (max. distance from wall 600 mm)	0,7/m ²
6	Connect Hanger Clip (not to be used in swimming hall environments)	0,7/m ²
7	For direct installation: Connect Direct Bracket, installed at 1200 mm centres	0,7/m ²
8	Connect Angle trim, fixed at 200 mm centres	as required
9	Combison XR (if required)	as required
10	Combison Barrier (if required)	as required
Δ Min. overall depth of system, with Adjustable hanger: 110 mm, with Direct bracket: 90 mm		-
δ Min. demounting depth: 230 mm		-

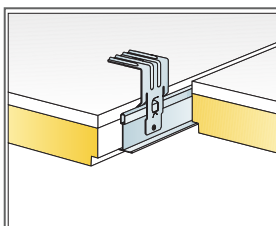
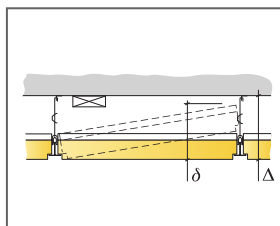

Direct bracket is secured with pop rivet or screw

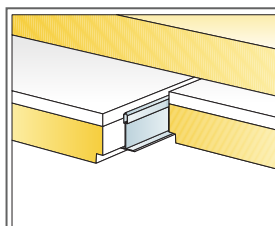

Additional absorber on top of ceiling

Size, mm	Max live load (N)	Min load bearing capacity (N)
600x600x55	0	220

Live load/load bearing capacity

Ecophon Combison™ XR

Ecophon Combison™ XR is a complementary product that is installed horizontally on top of the Combison ceiling tiles, to increase the sound reduction level between rooms. The product should cover as much of the ceiling surface as possible for the best acoustic performance.



JM, Stockholm, Sweden

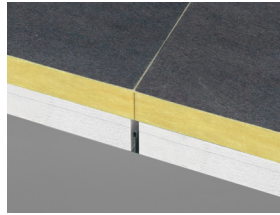
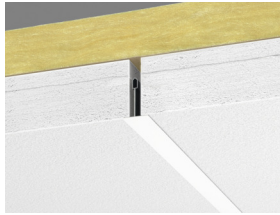

Combison XR system

Acoustic



Addition of Combison XR on top of Ecophon Combison ceiling systems will give increased insulation properties. For detailed information please see corresponding systems for Combison.

Product	D_{nfw} Weighted normalized flanking level difference, ISO 10848-2
+ 2 x 1200 XR	+ 3
+ 100% XR	+ 6

Circularity



Fully recyclable.

Fire safety



Country	Fire standard	Class
Europe	EN 13501-1	A2-s1,d0

The glass wool core of the tiles is tested and classified as non-combustible according to EN ISO 1182.

Humidity Resistance



Class C, relative humidity 95% and 30°C, according to EN 13964:2014

Visual appearance



Not applicable.

Cleanability



Not applicable.

Accessibility



The tiles are demountable.

Installation



Installed according to installation diagrams, installation guides and drawing aid.



Mechanical properties

Not applicable



System weight

	kg/m ²	Weight information is indicative and subject to variation.
Combison XR	1,5	



CE

Ecophon ceiling systems are CE marked according to the European harmonized standard EN13964:2014. CE marked construction products are covered by a Declaration of Performance (DOP) which enables customers and users to easily compare performance of products available on the European market.

INSTALLATION DIAGRAM (M440) FOR ECOPHON COMBISON XR

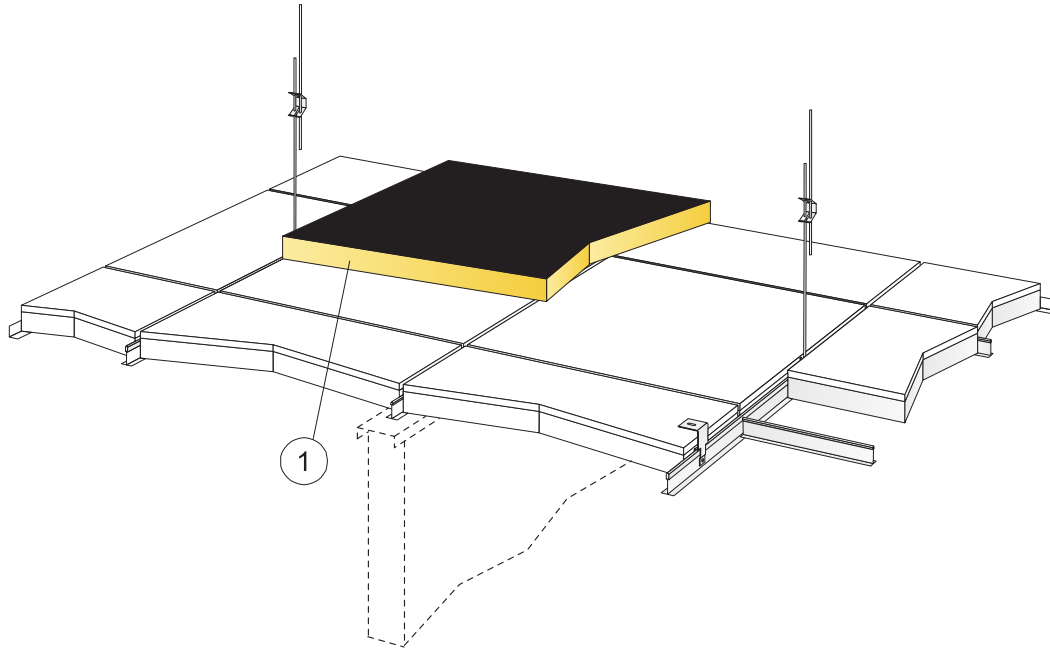

© Ecophon Group

QUANTITY SPECIFICATION (EXCL. WASTAGE)

		Size, mm
		1200x600
1	Extra Bass (1200x600x50 mm)	as required

Size, mm	Max live load (N)	Min load bearing capacity (N)
1200x600x50	0	-

Live load/load bearing capacity

Ecophon Combison™ Barrier

Ecophon Combison™ Barrier is an acoustic panel that is vertically installed above partitions in the plenum. Creates a sound barrier to improve the room to room sound insulation. Combison Barrier should be used together with other Ecophon systems for best acoustic performance.

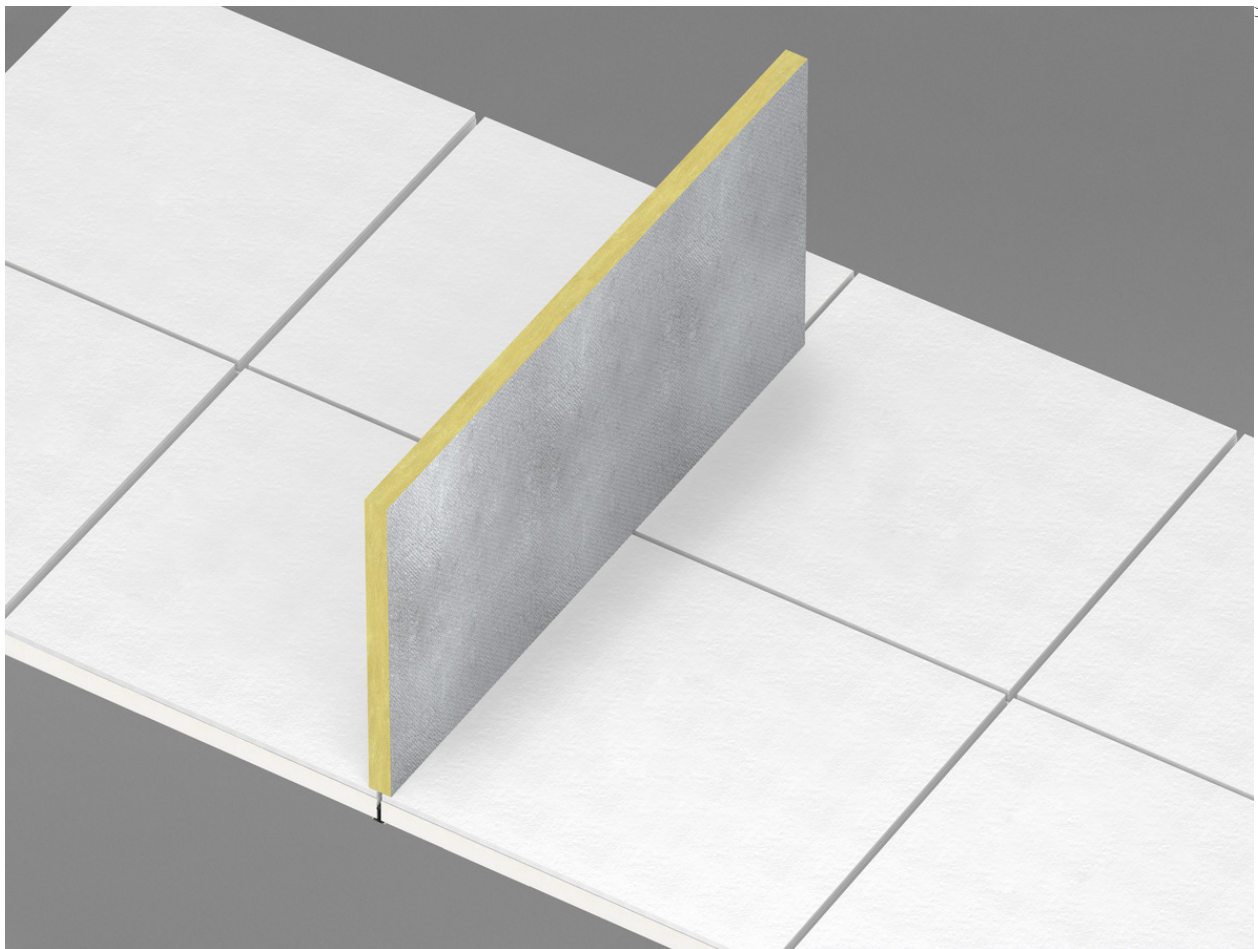

SYSTEM RANGE

 Size, mm	1200x600
Direct	•
Thickness (THK)	40
Inst. Diagr.	M160

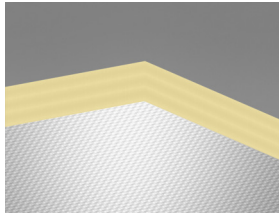

Combison Barrier tile



Combison Barrier system

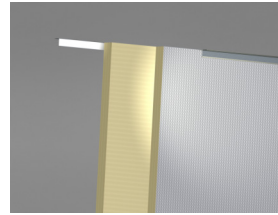

Section of Combison Barrier system

Acoustic



For use as acoustic barrier above partitions in plenum to improve the room to room sound insulation. The Combison Barrier should be used together with other Ecophon systems.

Circularity



Fully recyclable.

Fire safety



Country	Fire standard	Class
Europe	EN 13501-1	A2-s1,d0

The glass wool core of the tiles is tested and classified as non-combustible according to EN ISO 1182.

Humidity Resistance



Class C, relative humidity 95% and 30°C, according to EN 13964:2014

Visual appearance



Not applicable. The panel has aluminium foil on one side.

Cleanability



Not applicable.

Accessibility



The tiles are demountable.

Installation



Installed according to installation diagrams, installation guides and drawing aid. For information regarding minimum overall depth of system see quantity specification.

Mechanical properties



No additional live load is allowed.

CE



Ecophon ceiling systems are CE marked according to the European harmonized standard EN 13964:2014. CE marked construction products are covered by a Declaration of Performance (DOP) which enables customers and users to easily compare performance of products available on the European market.

INSTALLATION DIAGRAM (M160) FOR ECOPHON COMBISON BARRIER

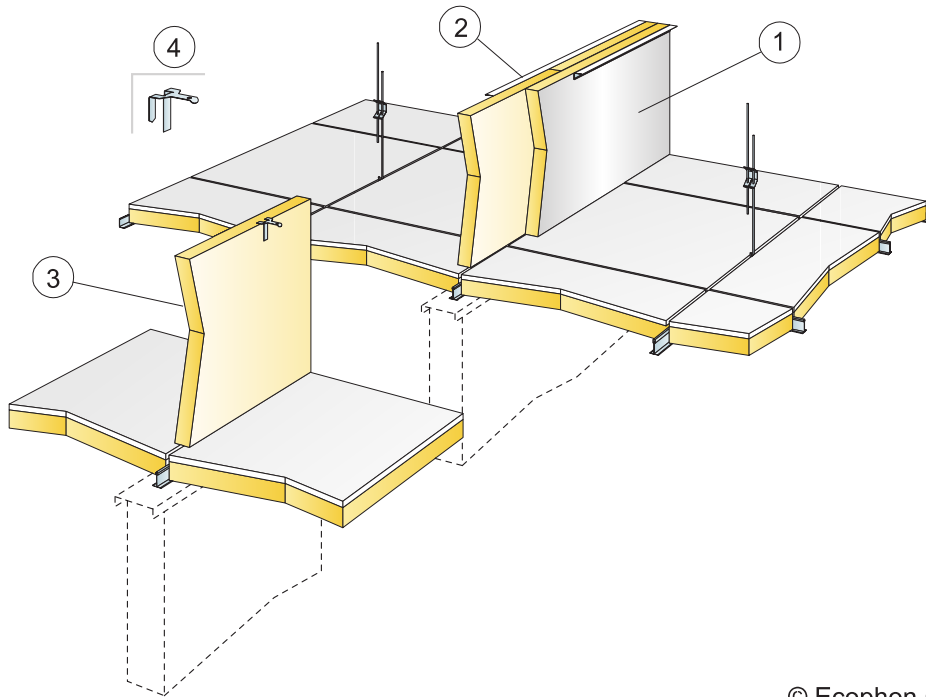

© Ecophon Group

QUANTITY SPECIFICATION (EXCL. WASTAGE)

		Size, mm
		1200x600
1	Combison Barrier in double layers with displaced joints and exposed alu-foil side	as required
2	Connect Angle trims position upper part of Barrier panels	as required
3	Combison Barrier in single layer	as required
4	Connect Frieze bracket, position upper part of Barrier panels	as required

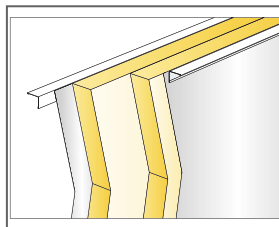

Double layers of Combison Barrier with Connect Angle trim

Size, mm	Max live load (N)	Min load bearing capacity (N)
1200x600x40	-	-

Live load/load bearing capacity



Ecophon Combison™ A, CAC 35

Ecophon Combison™ is the fastest and easiest way to combine features for both sound absorption and sound insulation between rooms. Ideal for installations where the partitions do not extend all the way up to the soffit. Combison can also help to reduce vertical noise from floor to floor. The panel is easy to handle, install and demount and it has a visible grid system. It is made from crimped glass fibre and has an Akutex FT surface on the front.



SYSTEM RANGE

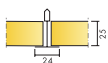

Size, mm	600x600	625x625	1200x600	1250x625
T24	•	•	•	•
Thickness (THK)	25	25	25	25
Inst. Diagr.	M528	M528 DIN	M528	M528 DIN

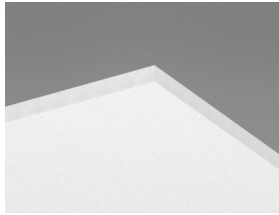

Combison dB42 A tile

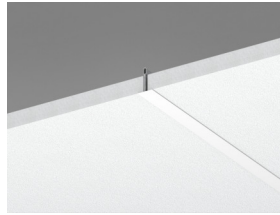

Section of Combison dB42 A system



Combison dB A system

Acoustic



Sound Absorption:

Test results according to EN ISO 354. Classification according to EN ISO 11654, and the single value ratings for Noise Reduction Coefficient, NRC and Sound Absorption Average, SAA according to ASTM C 423.

α_p , Practical sound absorption coefficient

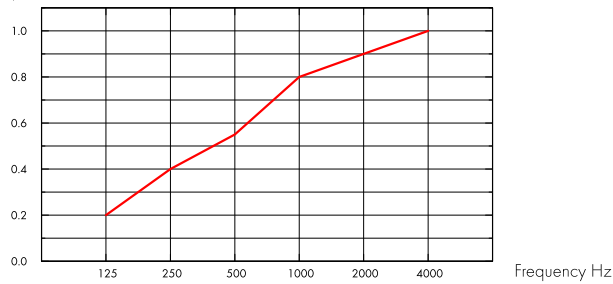

— Combison CAC35, 200 mm o.d.s.
o.d.s = overall depth of system

THK mm	o.d.s. mm	α_p , Practical sound absorption coefficient						α_w	Sound absorption class
		125 Hz	250 Hz	500 Hz	1000 Hz	2000 Hz	4000 Hz		
25	200	0.20	0.40	0.55	0.80	0.90	1.00	0.80	B

THK mm	o.d.s. mm	NRC	SAA
25	200	0.80	0.82

THK mm	D_{nfw}		CAC dB	
	Weighted normalized flanking level difference, ISO 10848-2		Ceiling Attenuation Class, ASTM 1414, ASTM E413	
25	34		35	

Indoor Air Quality



Certificate / Label	Standard
French VOC	A



Circularity



Fully recyclable.

Fire safety



Country	Fire standard	Class
Europe	EN 13501-1	A2-s1,d0

The glass wool core of the tiles is tested and classified as non-combustible according to EN ISO 1182.



Humidity Resistance

Class A, relative humidity 70% and 25°C, according to EN 13964:2014



Visual appearance

Akutex FT: White Frost, nearest NCS colour sample S 0500-N, 85% light reflectance. Gloss < 1. For more info see Colours and surfaces.



Cleanability

Akutex FT: Daily dusting and vacuum cleaning. Weekly wet wiping. For more info see Colours and surfaces.



Accessibility

The tiles are easily demountable. Minimum demounting depth according to installation diagrams.



Installation

Installed according to installation diagrams, installation guides and drawing aid. For information regarding minimum overall depth of system see quantity specification.



System weight

The weight of the system (including suspension grid) should be approximately 7 kg/m².



Mechanical properties

See table about Max live load and Min load bearing capacity and Functional demands, Mechanical properties at www.ecophon.com.



CE

Ecophon ceiling systems are CE marked according to the European harmonized standard EN 13964:2014. CE marked construction products are covered by a Declaration of Performance (DOP) which enables customers and users to easily compare performance of products available on the European market.

INSTALLATION DIAGRAM (M528) FOR ECOPHON COMBISON A, CAC 35

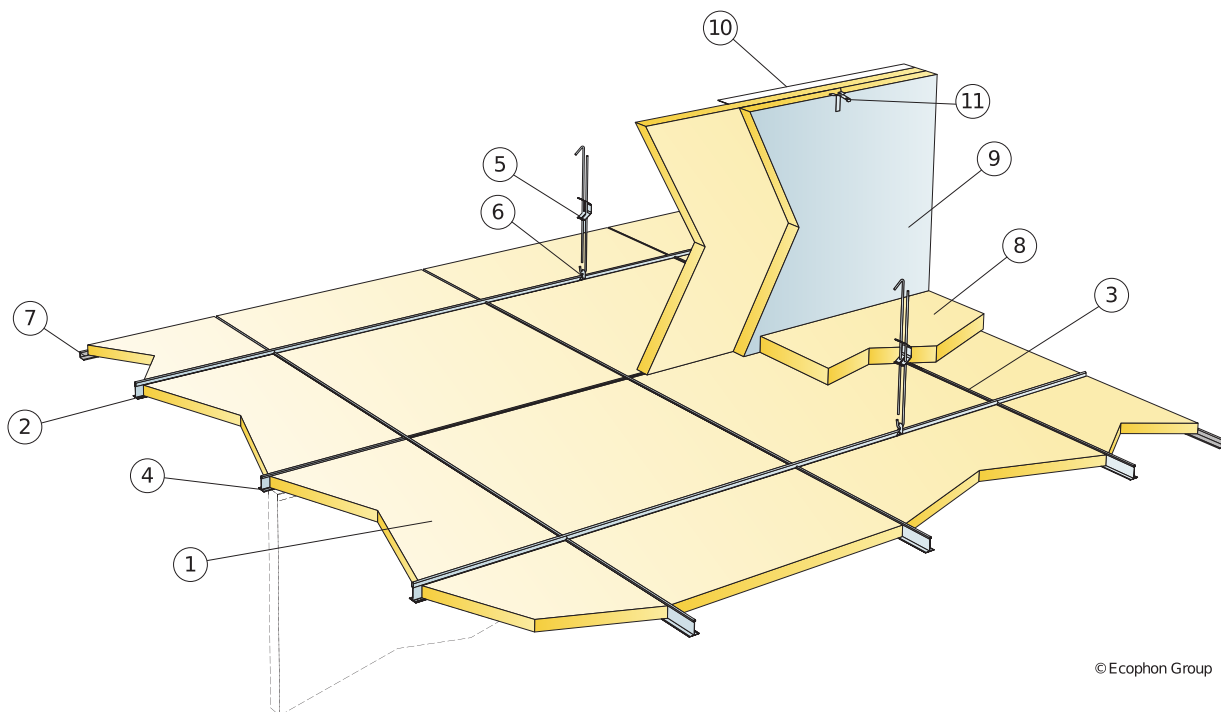

© Ecophon Group

QUANTITY SPECIFICATION (EXCL. WASTAGE)

	Size, mm	
	600x600	1200x600
1 Combison A, CAC 35	2,8/m ²	1,4/m ²
2 Connect T24 Main runner, installed at 1200 mm centres (max distance from wall 300 mm)	0,9m/m ²	0,9m/m ²
3 Connect T24 Cross tee, L=1200 mm, installed at 600 mm centres	1,7m/m ²	1,7m/m ²
4 Connect T24 Cross tee, L=600 mm	0,9m/m ²	-
5 Connect Adjustable Hanger, installed at 1200 mm centres (max. distance from wall 600 mm)	0,7/m ²	0,7/m ²
6 Connect Hanger Clip (not to be used in swimming hall environments)	0,7/m ²	0,7/m ²
7 Connect Angle trim, fixed at 200 mm centres	as required	as required
8 Combison XR (if required)	as required	as required
9 Combison Barrier (if required)	as required	as required
10 Connect Angle trims position upper part of Barrier panels (if required)	as required	as required
11 Connect Frieze bracket, position upper part of Barrier panels (if required)	as required	as required
Δ Min. overall depth of system: 100 mm	-	-
δ Min. demounting depth: 210 mm	-	-

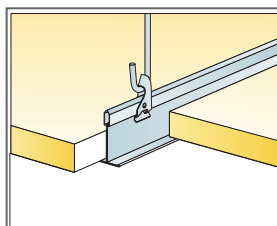
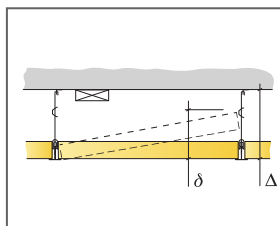

Suspension with adjustable hanger and clip

Size, mm	Max live load (N)	Min load bearing capacity (N)
600x600x25	15	160
1200x600x25	15	160

Live load/load bearing capacity

INSTALLATION DIAGRAM (M528 DIN) FOR ECOPHON COMBISON A, CAC 35

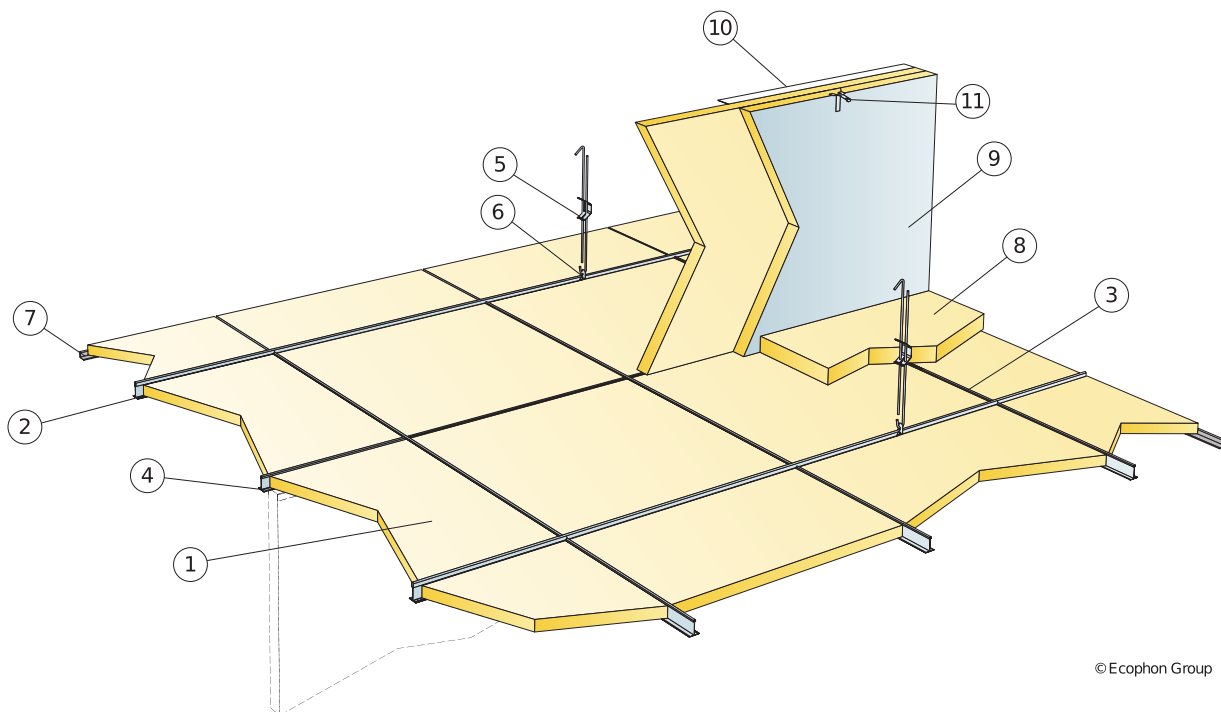

© Ecophon Group

QUANTITY SPECIFICATION (EXCL. WASTAGE)

	Size, mm	
	625x625	1250x625
1 Combison A, CAC 35	2,6/m ²	1,3/m ²
2 Connect T24 Main Runner, installed at 1250 mm centres	0,8m/m ²	0,8m/m ²
3 Connect T24 Cross Tee, L=1250 mm, installed at 625 mm centres for DIN (only white profiles)	1,6m/m ²	1,6m/m ²
4 Connect T24 Cross Tee, L=625 mm for DIN (only white profiles)	0,8m/m ²	-
5 Connect Adjustable Hanger, installed at 1250 mm centres (max. distance from wall 600 mm)	0,7/m ²	0,7/m ²
6 Connect Hanger Clip (not to be used in swimming hall environments)	0,7/m ²	0,7/m ²
7 Connect Angle trim, fixed at 200 mm centres	as required	as required
8 Combison XR (if required)	as required	as required
9 Combison Barrier (if required)	as required	as required
10 Connect Angle trims position upper part of Barrier panels (if required)	as required	as required
11 Connect Frieze bracket, position upper part of Barrier panels (if required)	as required	as required
Δ Min. overall depth of system: 100 mm	-	-
δ Min. demounting depth: 210 mm	-	-

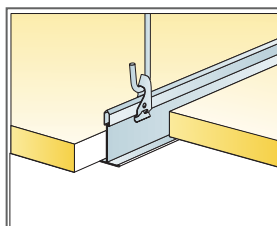
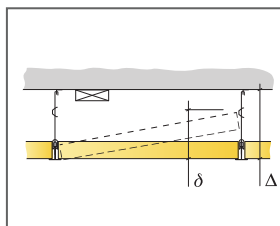

Suspension with adjustable hanger and clip

Size, mm	Max live load (N)	Min load bearing capacity (N)
625x625x25	-	-
1250x625x25	-	-

Live load/load bearing capacity



Ecophon Combison™ E, CAC 35

Ecophon Combison™ is the fastest and easiest way to combine features for both sound absorption and sound insulation between rooms. Ideal for installations where the partitions do not extend all the way up to the soffit. Combison can also help to reduce vertical noise from floor to floor. The panel is easy to handle, install and demount and it has a visible grid system. It is made from crimped glass fibre and has an Akutex FT surface on the front.



SYSTEM RANGE

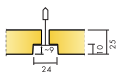

Size, mm	600x600	625x625	1200x600	1250x625
T24	•	•	•	•
Thickness (THK)	25	25	25	25
Inst. Diag.	M530	M530 DIN	M530	M530 DIN



Combison dB42 A tile

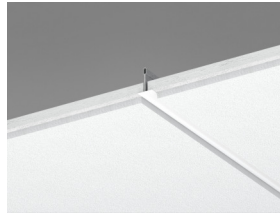

Section of Combison dB42 A system

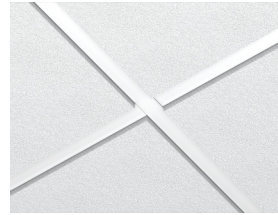

Combison dB A system

Acoustic



Sound Absorption:

Test results according to EN ISO 354. Classification according to EN ISO 11654, and the single value ratings for Noise Reduction Coefficient, NRC and Sound Absorption Average, SAA according to ASTM C 423.

α_p , Practical sound absorption coefficient

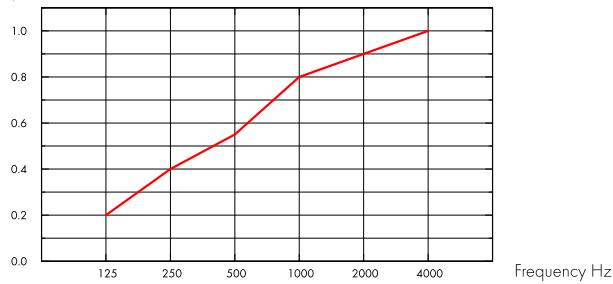

— Combison CAC35, 200 mm o.d.s.
o.d.s = overall depth of system

THK mm	o.d.s. mm	α_p , Practical sound absorption coefficient						α_w	Sound absorption class
		125 Hz	250 Hz	500 Hz	1000 Hz	2000 Hz	4000 Hz		
25	200	0.20	0.40	0.55	0.80	0.90	1.00	0.80	B

THK mm	o.d.s. mm	NRC	SAA
25	200	0.80	0.82

THK mm	D_{nfw}		CAC dB
	Weighted normalized flanking level difference, ISO 10848-2		Ceiling Attenuation Class, ASTM 1414, ASTM E413
25	34		35

Indoor Air Quality



Certificate / Label	Standard
French VOC	A



Circularity



Fully recyclable.

Fire safety



Country	Fire standard	Class
Europe	EN 13501-1	A2-s1,d0

The glass wool core of the tiles is tested and classified as non-combustible according to EN ISO 1182.



Humidity Resistance

Class A, relative humidity 70% and 25°C, according to EN 13964:2014



Visual appearance

Akutex FT: White Frost, nearest NCS colour sample S 0500-N, 85% light reflectance. Gloss < 1. For more info see Colours and surfaces.



Cleanability

Akutex FT: Daily dusting and vacuum cleaning. Weekly wet wiping. For more info see Colours and surfaces.



Accessibility

The tiles are easily demountable. Minimum demounting depth according to installation diagrams.



Installation

Installed according to installation diagrams, installation guides and drawing aid. For information regarding minimum overall depth of system see quantity specification.



System weight

The weight of the system (including suspension grid) should be approximately 7 kg/m².



Mechanical properties

See table about Max live load and Min load bearing capacity and Functional demands, Mechanical properties at www.ecophon.com.



CE

Ecophon ceiling systems are CE marked according to the European harmonized standard EN 13964:2014. CE marked construction products are covered by a Declaration of Performance (DOP) which enables customers and users to easily compare performance of products available on the European market.

INSTALLATION DIAGRAM (M530) FOR ECOPHON COMBISON E, CAC 35

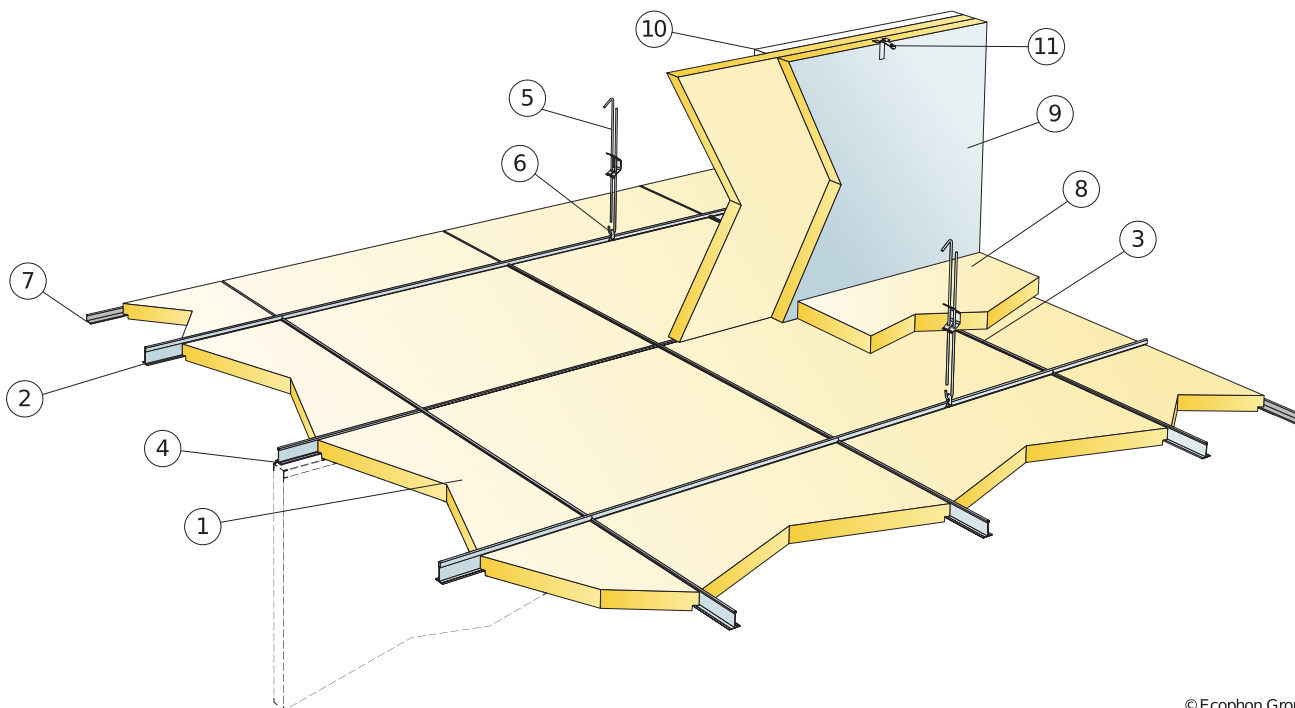

© Ecophon Group

QUANTITY SPECIFICATION [EXCL. WASTAGE]

	Size, mm	
	600x600	1200x600
1 Combison E, CAC 35	2,8/m ²	1,4/m ²
2 Connect T24 Main runner, installed at 1200 mm centres (max distance from wall 300 mm)	0,9m/m ²	0,9m/m ²
3 Connect T24 Cross tee, L=1200 mm, installed at 600 mm centres	1,7m/m ²	1,7m/m ²
4 Connect T24 Cross tee, L=600 mm	0,9m/m ²	-
5 Connect Adjustable Hanger, installed at 1200 mm centres (max. distance from wall 600 mm)	0,7/m ²	0,7/m ²
6 Connect Hanger Clip (not to be used in swimming hall environments)	0,7/m ²	0,7/m ²
7 Connect Angle trim, fixed at 200 mm centres	as required	as required
8 Combison XR (if required)	as required	as required
9 Combison Barrier (if required)	as required	as required
10 Connect Angle trims position upper part of Barrier panels (if required)	as required	as required
11 Connect Frieze bracket, position upper part of Barrier panels (if required)	as required	as required
Δ Min. overall depth of system: 100 mm	-	-
δ Min. demounting depth: 210 mm	-	-

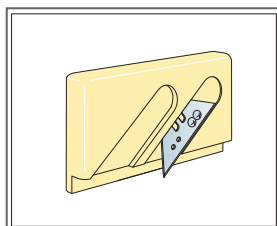
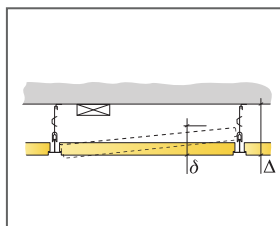

Cutting tool E

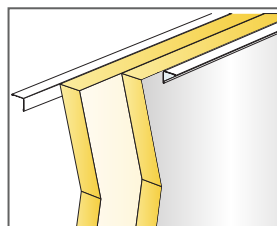

Si il y a deux barrières, la feuille alu doit être à l'extérieur

Size, mm	Max live load (N)	Min load bearing capacity (N)
600x600x25	15	160
1200x600x25	15	160

Live load/load bearing capacity

INSTALLATION DIAGRAM (M530 DIN) FOR ECOPHON COMBISON E, CAC 35

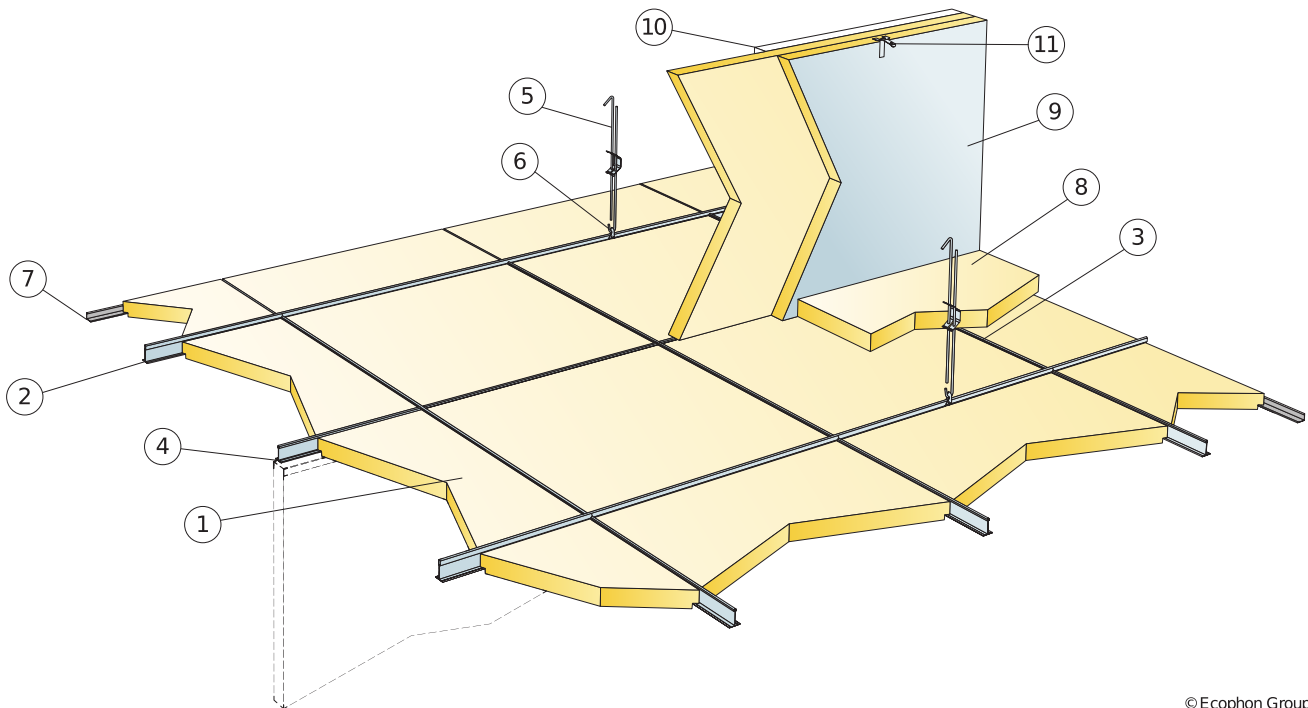

© Ecophon Group

QUANTITY SPECIFICATION (EXCL. WASTAGE)

	Size, mm	
	625x625	1250x625
1 Combison E, CAC 35	2,6/m ²	1,3/m ²
2 Connect T24 Main Runner, installed at 1250 mm centres	0,8m/m ²	0,8m/m ²
3 Connect T24 Cross Tee, L=1250 mm, installed at 625 mm centres for DIN (only white profiles)	1,6m/m ²	1,6m/m ²
4 Connect T24 Cross Tee, L=625 mm for DIN (only white profiles)	0,8m/m ²	-
5 Connect Adjustable Hanger, installed at 1250 mm centres (max. distance from wall 600 mm)	0,7/m ²	0,7/m ²
6 Connect Hanger Clip (not to be used in swimming hall environments)	0,7/m ²	0,7/m ²
7 Connect Angle trim, fixed at 200 mm centres	as required	as required
8 Combison XR (if required)	as required	as required
9 Combison Barrier (if required)	as required	as required
10 Connect Angle trims position upper part of Barrier panels (if required)	as required	as required
11 Connect Frieze bracket, position upper part of Barrier panels (if required)	as required	as required
Δ Min. overall depth of system: 100 mm	-	-
δ Min. demounting depth: 210 mm	-	-

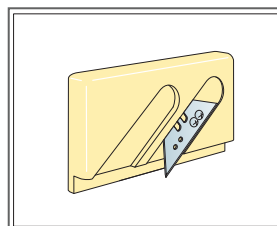
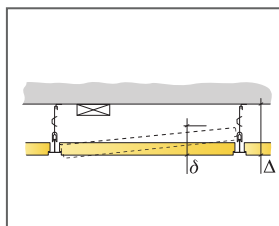

Cutting tool E

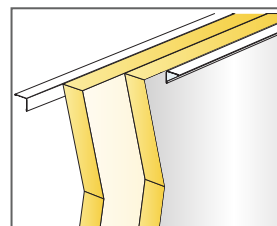

Si il y a deux barrières, la feuille alu doit être à l'extérieur

Size, mm	Max live load (N)	Min load bearing capacity (N)
625x625x25	-	-
1250x625x25	-	-

Live load/load bearing capacity