

Ecophon Hygiene Clinic™ A

Ecophon Hygiene Clinic™ A has an exposed grid, suitable for dry areas. The absorbers have low emission levels, ensuring high indoor air quality. They are resistant to mould and bacteria growth and withstand HPV cleaning.

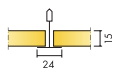

SYSTEM RANGE



Size, mm	600x600	1200x600
T24	•	•
Thickness (THK)	15	15
Inst. Diagr.	M338	M338

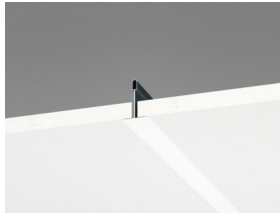

Section of Hygiene Clinic A system

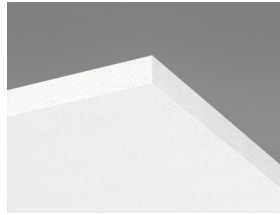

Hygiene Clinic A tile



Hygiene Clinic A system

Acoustic



Sound Absorption:

Test results according to EN ISO 354. Classification according to EN ISO 11654.

α_p , Practical sound absorption coefficient

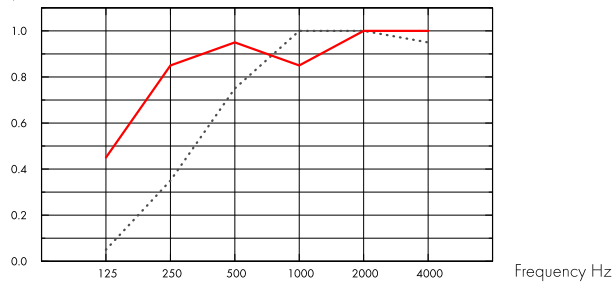

... Hygiene Clinic A 15 mm, 50 mm o.d.s.

— Hygiene Clinic A 15 mm, 200 mm o.d.s.

o.d.s = overall depth of system

THK mm	o.d.s. mm	α_p , Practical sound absorption coefficient						α_w	Sound absorption class
		125 Hz	250 Hz	500 Hz	1000 Hz	2000 Hz	4000 Hz		
15	50	0.05	0.35	0.75	1.00	1.00	0.95	0.65	C
15	200	0.45	0.85	0.95	0.85	1.00	1.00	0.95	A

THK mm	o.d.s. mm	NRC	SAA
15	50	0.80	0.79
15	200	0.90	0.91

Indoor Air Quality



Certificate / Label	
Eurofins Indoor Air Comfort®	IAC
French VOC	A
Finnish M1	•



Cradle to Cradle Certified®



This product is Cradle to Cradle Certified® at Bronze level (version 4.0).



Material Health

This product has received a C2C Certified Material Health Certificate™ at the Silver level (standard version 4.0). The C2C Certified Material Health Certificate™ is a verification of the health and safety of a product's composition using the Material Health requirements of the Cradle-to-Cradle Certified Product Standard.



Environmental Footprint

kg CO ₂ equiv/m ²	
Hygiene Clinic A	2,60

Life-cycle stages A1 to C4 from EPD, in conformity with ISO 14025 / EN 15804



Circularity

Minimum post-consumer recycled content	46%
Recyclability	Fully recyclable



Fire safety

Country	Class	
Europe	EN 13501-1	A2-s1,d0

The glass wool core of the tiles is tested and classified as non-combustible according to EN ISO 1182.



Humidity Resistance

Class C, relative humidity 95% and 30°C, according to EN 13964:2014



Visual appearance

White 500, nearest NCS colour sample S 0500-N, 84% light reflectance.



Cleanability

Daily dusting and vacuum cleaning. Weekly wet wiping.



Advanced Cleanability

Withstand use of hydrogen peroxide vapor and compatible with UV-C disinfection, BIFMA HCF 8.1-2019



Mould and Bacterial Resistance

Standard/Method	
ISO 846 A	0
ISO 846 C	0



Clean Room

	Standard/Method	Class
ISO 14644	Particle cleanliness class	ISO 4
NF S 90-351	Microbiological class	M1/area 4
NF S 90-351	Particle elimination kinetics	CP(0,5) 5



Accessibility

The tiles are easily demountable. Minimum demounting depth according to installation diagrams.



Installation

Installed according to installation diagrams, installation guides and drawing aid. For information regarding minimum overall depth of system see quantity specification.



System weight

The weight of the system (including suspension grid) should be approximately 2,5 kg/m².



Mechanical properties

See table about Max live load and Min load bearing capacity and Functional demands, Mechanical properties at www.ecophon.com.



CE

Ecophon ceiling systems are CE marked according to the European harmonized standard EN13964:2014. CE marked construction products are covered by a Declaration of Performance (DOP) which enables customers and users to easily compare performance of products available on the European market.

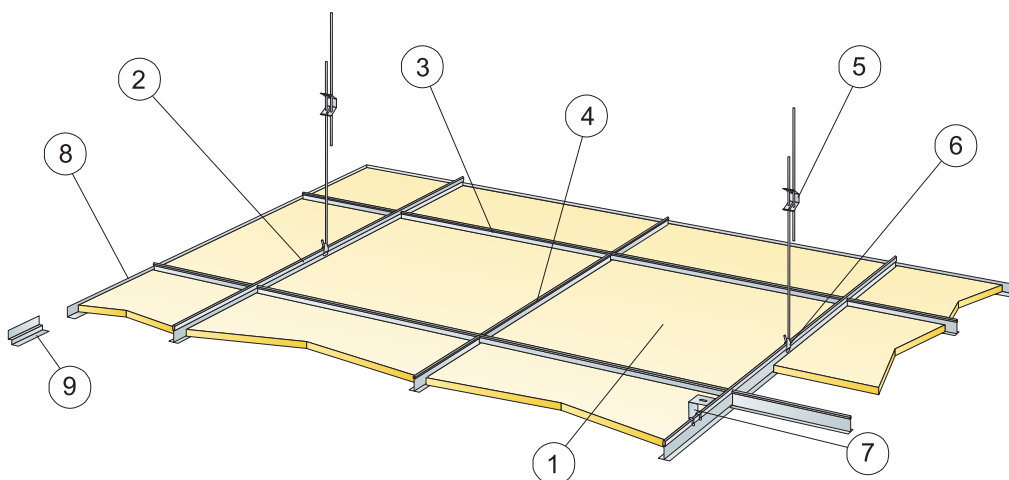

©Saint-Gobain Ecophon AB

QUANTITY SPECIFICATION (EXCL. WASTAGE)

	Size, mm	
	600x600	1200x600
1 Hygiene Clinic A	2,8/m ²	1,4/m ²
2 Connect T24 Main Runner, installed at 1200 mm centres (max distance from wall 300 mm)	0,9m/m ²	0,9m/m ²
3 Connect T24 Cross Tee, L=1200 mm, installed at 600 mm centres	1,7m/m ²	1,7m/m ²
4 Connect T24 Cross Tee, L=600 mm	0,9m/m ²	-
5 Connect Adjustable Hanger, installed at 1200 mm centres (max. distance from wall 600 mm)	0,7/m ²	0,7/m ²
6 Connect Hanger Clip (not to be used in swimming hall environments)	0,7/m ²	0,7/m ²
7 For direct installation: Connect Direct Bracket, installed at 1200 mm centres	0,7/m ²	0,7/m ²
8 Connect Angle Trim, fixed at 300 mm centres	as required	as required
9 Connect Shadowline Trim, fixed at 300 mm centres	as required	as required
Δ Min. overall depth of system, with adjustable hanger: 100 mm, with direct bracket: 50 mm	-	-
δ Min. demounting depth: 120 mm	-	-

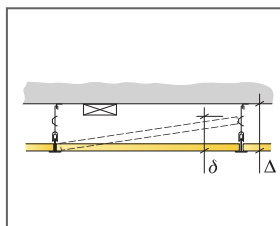

See Quantity Specification

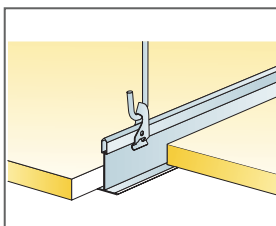

Suspension with Connect Adjustable Hanger and Connect Hanger Clip

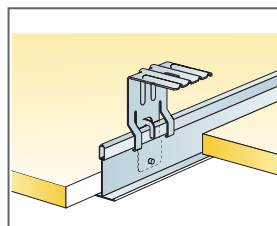

Suspension with Connect Direct Bracket

Size, mm	Max live load (N)	Min load bearing capacity (N)
600x600x15	50	160
1200x600x15	50	160

Live load/load bearing capacity

Ecophon Hygiene Clinic™ E

Ecophon Hygiene Clinic™ E has a recessed visible grid and a tegular edge design, suitable for dry areas. The absorbers have low emission levels, ensuring high indoor air quality. They are resistant to mould and bacteria growth and withstand HPV cleaning.



Centre de dialyse de Pau

SYSTEM RANGE

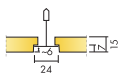

Size, mm	600x600	1200x600
T24	•	•
Thickness (THK)	15	15
Inst. Diag.	M339	M339



Hygiene Clinic E tile

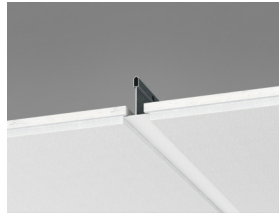

Section of Hygiene Clinic E system

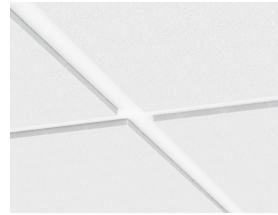

Hygiene Clinic E system

Acoustic



Sound Absorption:

Test results according to EN ISO 354. Classification according to EN ISO 11654, and the single value ratings for Noise Reduction Coefficient, NRC and Sound Absorption Average, SAA according to ASTM C 423.

α_p , Practical sound absorption coefficient

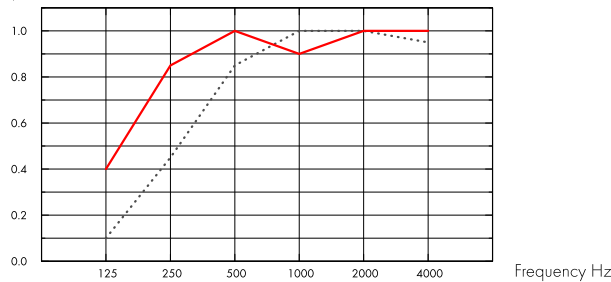

..... Hygiene Clinic E 15 mm, 60 mm o.d.s.
 — Hygiene Clinic E 15 mm, 200 mm o.d.s.
 o.d.s = overall depth of system

THK mm	o.d.s. mm	α_p , Practical sound absorption coefficient						α_w	Sound absorption class
		125 Hz	250 Hz	500 Hz	1000 Hz	2000 Hz	4000 Hz		
15	60	0.10	0.45	0.85	1.00	1.00	0.95	0.75	C
15	200	0.40	0.85	1.00	0.90	1.00	1.00	1.00	A



Indoor Air Quality

Certificate / Label	
Eurofins Indoor Air Comfort®	IAC
French VOC	A
Finnish M1	•



Cradle to Cradle Certified®



This product is Cradle to Cradle Certified® at Bronze level (version 4.0).



Material Health

This product has received a C2C Certified Material Health Certificate™ at the Silver level (standard version 4.0). The C2C Certified Material Health Certificate™ is a verification of the health and safety of a product's composition using the Material Health requirements of the Cradle-to-Cradle Certified Product Standard.



Environmental Footprint

	kg CO ₂ equiv/m ²	Life-cycle stages A1 to C4 from EPD, in conformity with ISO 14025 / EN 15804
Hygiene Clinic E	2,20	



Circularity

Minimum post-consumer recycled content	45%
Recyclability	Fully recyclable



Fire safety

Country	Class	
Europe	EN 13501-1	A2-s1,d0

The glass wool core of the tiles is tested and classified as non-combustible according to EN ISO 1182.



Humidity Resistance

Class C, relative humidity 95% and 30°C, according to EN 13964:2014



Visual appearance

White 500, nearest NCS colour sample S 0500-N, 84% light reflectance.



Cleanability

Daily dusting and vacuum cleaning. Weekly wet wiping.



Advanced Cleanability

Withstand use of hydrogen peroxide vapor and compatible with UV-C disinfection, BIFMA HCF 8.1-2019



Mould and Bacterial Resistance

Standard/Method	
ISO 846 A	0
ISO 846 C	0



Clean Room

	Standard/Method	Class
ISO 14644	Particle cleanliness class	ISO 4
NF S 90-351	Microbiological class	M1/area 4
NF S 90-351	Particle elimination kinetics	CP(0,5) 5



Accessibility

The tiles are easily demountable. Minimum demounting depth according to installation diagrams.



Installation

Installed according to installation diagrams, installation guides and drawing aid. For information regarding minimum overall depth of system see quantity specification.



System weight

The weight of the system (including suspension grid) should be approximately 2,5 kg/m².



Mechanical properties

See table about Max live load and Min load bearing capacity and Functional demands, Mechanical properties at www.ecophon.com.



CE

Ecophon ceiling systems are CE marked according to the European harmonized standard EN13964:2014. CE marked construction products are covered by a Declaration of Performance (DOP) which enables customers and users to easily compare performance of products available on the European market.

INSTALLATION DIAGRAM (M339) FOR ECOPHON HYGIENE CLINIC™ E

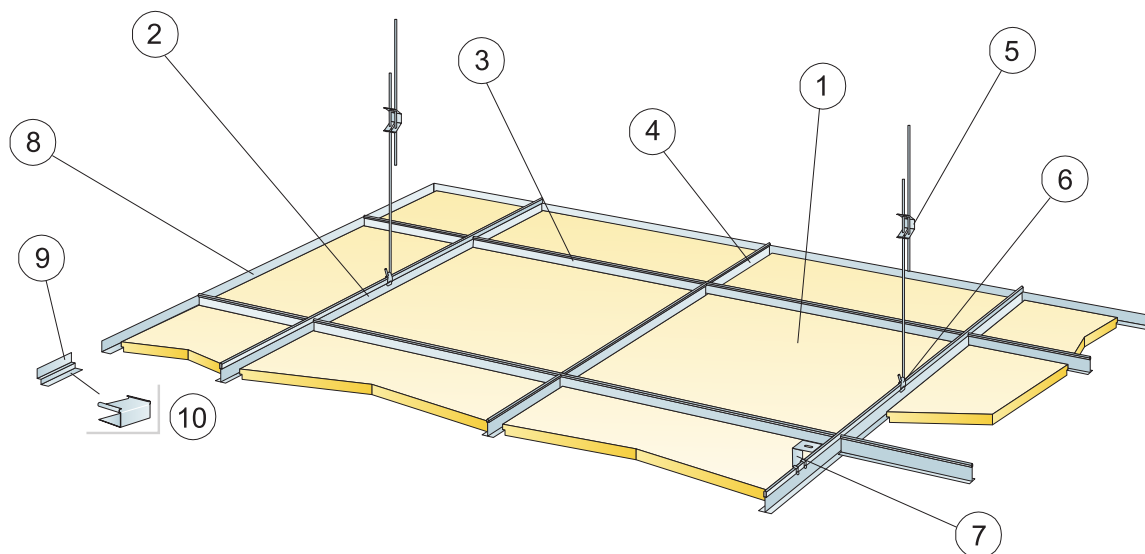

© Saint-Gobain Ecophon AB

QUANTITY SPECIFICATION (EXCL. WASTAGE)

	Size, mm	
	600x600	1200x600
1 Hygiene Clinic E	2,8/m ²	1,4/m ²
2 Connect T24 Main Runner, installed at 1200 mm centres (max distance from wall 300 mm)	0,9m/m ²	0,9m/m ²
3 Connect T24 Cross Tee, L=1200 mm, installed at 600 mm centres	1,7m/m ²	1,7m/m ²
4 Connect T24 Cross Tee, L=600 mm	0,9m/m ²	-
5 Connect Adjustable Hanger, installed at 1200 mm centres (max. distance from wall 600 mm)	0,7/m ²	0,7/m ²
6 Connect Hanger Clip (not to be used in swimming hall environments)	0,7/m ²	0,7/m ²
7 For direct installation: Connect Direct Bracket, installed at 1200 mm centres	0,7/m ²	0,7/m ²
8 Connect Angle Trim, fixed at 300 mm centres	as required	as required
9 Connect Shadow-line Trim, fixed at 300 mm centres	as required	as required
10 Connect E-plug (for Connect Shadow-line Trim)	as required	as required
Δ Min. overall depth of system, with adjustable hanger: 110 mm, with direct bracket: 60 mm	-	-
δ Min. demounting depth: T15: 110 mm, T24: 90 mm	-	-

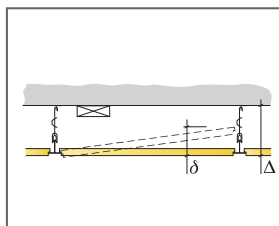

See Quantity Specification

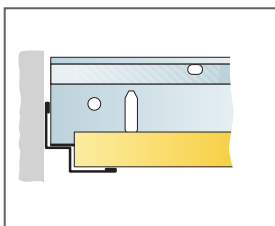

Straight cut and T-profile on top of Connect Shadow-line Trim

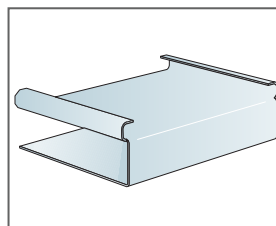

Connect E-plug

Size, mm	Max live load (N)	Min load bearing capacity (N)
600x600x15	50	160
1200x600x15	50	160

Live load/load bearing capacity



Ecophon Hygiene Meditec™

A

Ecophon Hygiene Meditec™ A has an exposed grid, suitable for dry areas where disinfection and/or cleaning is required on a regular basis. The surface is resistant to mould and bacteria growth and common detergents and disinfectants. The absorbers have low emission levels, ensuring high indoor air quality.



Spain

SYSTEM RANGE

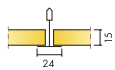

Size, mm	600x600	1200x600
T24	•	•
Thickness (THK)	15	15
Inst. Diag.	M255	M255

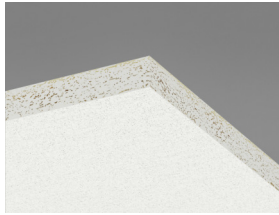

Hygiene Meditec A tile



Hygiene Meditec A C1 section with Connect Universal clip



Hygiene Meditec A C1 system

Acoustic



Sound Absorption:

Test results according to EN ISO 354. Classification according to EN ISO 11654.

α_p , Practical sound absorption coefficient

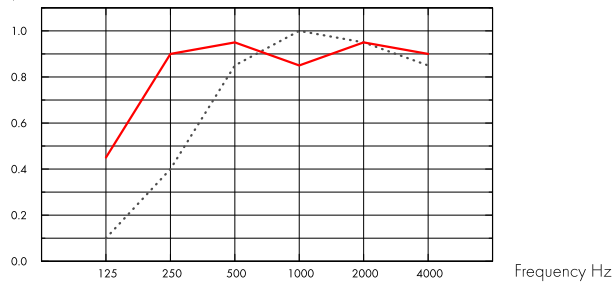

... Hygiene Meditec A 15 mm, 50 mm o.d.s.

— Hygiene Meditec A 15 mm, 200 mm o.d.s.

o.d.s = overall depth of system

THK mm	o.d.s. mm	α_p , Practical sound absorption coefficient						α_w	Sound absorption class
		125 Hz	250 Hz	500 Hz	1000 Hz	2000 Hz	4000 Hz		
15	50	0.10	0.40	0.85	1.00	0.95	0.85	0.70	C
15	200	0.45	0.90	0.95	0.85	0.95	0.90	0.95	A

THK mm	o.d.s. mm	NRC	SAA
15	50	0.80	0.83
15	400	0.85	0.89

Indoor Air Quality



Certificate / Label	All Products
Eurofins Indoor Air Comfort®	IAC Gold
French VOC	A+
Finnish M1	•



Cradle to Cradle Certified®



This product is Cradle to Cradle Certified® at Bronze level (version 4.0).



Material Health

This product has received a C2C Certified Material Health Certificate™ at the Silver level (standard version 4.0). The C2C Certified Material Health Certificate™ is a verification of the health and safety of a product's composition using the Material Health requirements of the Cradle-to-Cradle Certified Product Standard.



Environmental Footprint

	kg CO ₂ equiv/m ²
Hygiene Meditec A	2,70

Life-cycle stages A1 to C4 from EPD, in conformity with ISO 14025 / EN 15804



Circularity

Minimum post-consumer recycled content	44%
Recyclability	Fully recyclable



Fire safety

Country	Class	
Europe	EN 13501-1	A2-s1,d0

The glass wool core of the tiles is tested and classified as non-combustible according to EN ISO 1182.



Humidity Resistance

Class C, relative humidity 95% and 30°C, according to EN 13964:2014



Visual appearance

White 500, nearest NCS colour sample S 0500-N, 84% light reflectance.



Cleanability

Daily dusting and vacuum cleaning. Weekly wet wiping.



Advanced Cleanability

Withstand use of hydrogen peroxide vapor.



Surface Endurance

Product tested according to ISO 11998, and withstand 200 cycles.



Chemical resistance/Disinfection

Chemical	Active Substance	Concentration
Ethanol	Ethanol	70%
Chlorine	Sodium Hypochlorite solution	2,5%
Virkon S	Dipotassium peroxodisulphate; Sulphamidic acid	1%
Isopropanol	Isopropyl Alcohol	70%

Tested according to ISO 11998 and withstand the following chemicals or disinfectants.



Mould and Bacterial Resistance

Standard/Method	
ISO 846 A	0
ISO 846 C	0



Clean Room

	Standard/Method	Class
ISO 14644	Particle cleanliness class	ISO 4
NF S 90-351	Microbiological class	M1/area 4
NF S 90-351	Particle elimination kinetics	CP(0,5) 5



Accessibility

The tiles are demountable. Minimum demounting depth according to installation diagram. The tiles are secured using clips to allow for effective cleaning. The clips are easily removable from above the ceiling. An easy-to-open Connect Inspection hatch is available to simplify access to the ceiling void.



Installation

Installed according to installation diagrams, installation guides and drawing aid. Cut panels must be sealed with Connect Edge sealant. Penetrations must be sealed with a suitable sealant.



Mechanical properties

See table about Max live load and Min load bearing capacity and Functional demands, Mechanical properties at www.ecophon.com.



System weight

The weight of the system (including suspension grid) should be approximately 2,5 kg/m².



CE

Ecophon ceiling systems are CE marked according to the European harmonized standard EN13964:2014. CE marked construction products are covered by a Declaration of Performance (DOP) which enables customers and users to easily compare performance of products available on the European market.

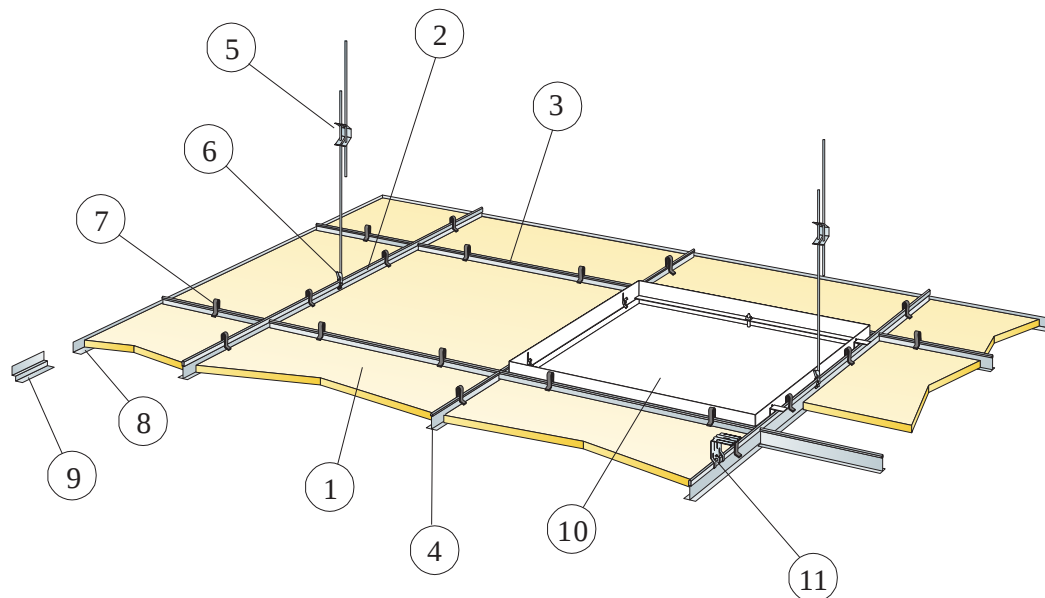

© Saint-Gobain Ecophon AB

QUANTITY SPECIFICATION (EXCL. WASTAGE)

	Size, mm	
	600x600	1200x600
1 Hygiene Meditec A	2,8/m ²	1,4/m ²
2 Connect T24 Main Runner, installed at 1200 mm centres (max distance from wall 300 mm)	0,9m/m ²	0,9m/m ²
3 Connect T24 Cross Tee, L=1200 mm, installed at 600 mm centres	1,7m/m ²	1,7m/m ²
4 Connect T24 Cross Tee, L=600 mm	0,9m/m ²	-
5 Connect Adjustable Hanger, installed at 1200 mm centres (max. distance from wall 600 mm)	0,7/m ²	0,7/m ²
6 Connect Hanger Clip (not to be used in swimming hall environments)	0,7/m ²	0,7/m ²
7 Connect Universal Clip	11/m ²	7/m ²
8 Alt. Connect Angle Trim, fixed c300	as required	as required
9 Alt. Connect Shadow-line Trim, fixed c300	as required	as required
10 Connect Inspection Hatch	as required	as required
11 For direct installation: Connect Direct Bracket, installed at 1200 mm centres	0,7/m ²	0,7/m ²
Δ Min. overall depth of system, with adjustable hanger and clip: 150 mm, with direct fixing without clip: 50 mm.	-	-
δ Min. demounting depth: With clip: 150 mm. Without clip: 100 mm.	-	-

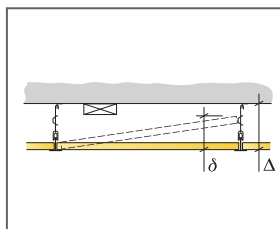

See Quantity Specification

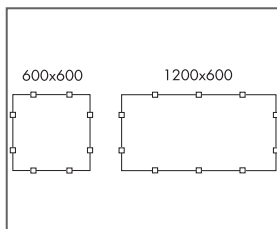

Arrangement of clips

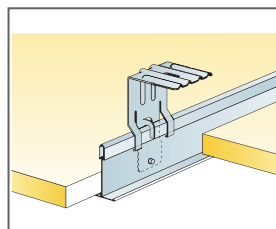

Suspension with Connect Direct Bracket

Size, mm	Max live load (N)	Min load bearing capacity (N)
600x600x15	50	160
1200x600x15	50	160

Live load/load bearing capacity

Ecophon Hygiene Meditec™ E

Ecophon Hygiene Meditec™ E has a recessed visible grid and a tegular edge design, suitable for dry areas where disinfection and/or cleaning is required on a regular basis. The surface is resistant to mould and bacteria growth and to common detergents and disinfectants.



SYSTEM RANGE

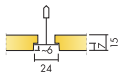

Size, mm	600x600	1200x600
T24	•	•
Thickness (THK)	15	15
Inst. Diag.	M256	M256

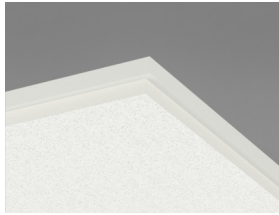

Hygiene Meditec E tile



Hygiene Meditec E C1 section with Connect Universal clip



Hygiene Meditec E C1 system

Acoustic



Sound Absorption:

Test results according to EN ISO 354. Classification according to EN ISO 11654.

α_p , Practical sound absorption coefficient

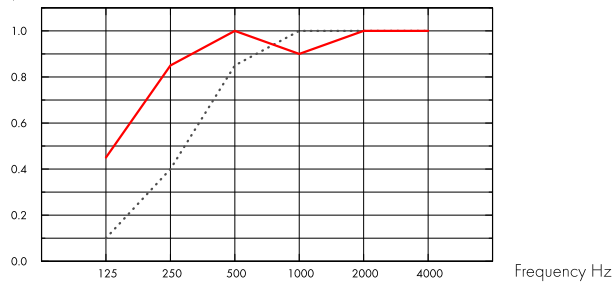

... Hygiene Meditec E 15 mm, 60 mm o.d.s.

— Hygiene Meditec E 15 mm, 200 mm o.d.s.

o.d.s = overall depth of system

THK mm	o.d.s. mm	α_p , Practical sound absorption coefficient						α_w	Sound absorption class
		125 Hz	250 Hz	500 Hz	1000 Hz	2000 Hz	4000 Hz		
15	60	0.10	0.40	0.85	1.00	1.00	1.00	0.70	C
15	200	0.45	0.85	1.00	0.90	1.00	1.00	1.00	A

THK mm	o.d.s. mm	NRC	SAA
15	60	0.90	0.87
15	400	0.85	0.89

Indoor Air Quality



Certificate / Label	
Eurofins Indoor Air Comfort®	IAC Gold
French VOC	A+
Finnish M1	•



Cradle to Cradle Certified®



This product is Cradle to Cradle Certified® at Bronze level (version 4.0).



Material Health

This product has received a C2C Certified Material Health Certificate™ at the Silver level (standard version 4.0). The C2C Certified Material Health Certificate™ is a verification of the health and safety of a product's composition using the Material Health requirements of the Cradle-to-Cradle Certified Product Standard.



Environmental Footprint

	kg CO ₂ equiv/m ²
Hygiene Meditec E	2,40

Life-cycle stages A1 to C4 from EPD, in conformity with ISO 14025 / EN 15804



Circularity

Minimum post-consumer recycled content	43%
Recyclability	Fully recyclable



Fire safety

Country	Class	
Europe	EN 13501-1	A2-s1,d0

The glass wool core of the tiles is tested and classified as non-combustible according to EN ISO 1182.



Humidity Resistance

Class C, relative humidity 95% and 30°C, according to EN 13964:2014



Visual appearance

White 500, nearest NCS colour sample S 0500-N, 84% light reflectance.



Cleanability

Daily dusting and vacuum cleaning. Weekly wet wiping.



Advanced Cleanability

Withstand use of hydrogen peroxide vapor.



Mould and Bacterial Resistance

Standard/Method	
ISO 846 A	0
ISO 846 C	0



Surface Endurance

Product tested according to ISO 11998, and withstand 200 cycles.



Chemical resistance/Disinfection

Chemical	Active Substance	Concentration
Ethanol	Ethanol	70%
Chlorine	Sodium Hypochlorite solution	2,5%
Virkon S	Dipotassium peroxodisulphate; Sulphamic acid	1%
Isopropanol	Isopropyl Alcohol	70%

Tested according to ISO 11998 and withstand the following chemicals or disinfectants.



Clean Room

	Standard/Method	Class
ISO 14644	Particle cleanliness class	ISO 4
NF S 90-351	Microbiological class	M1/area 4
NF S 90-351	Particle elimination kinetics	CP(0,5) 5



Accessibility

The tiles are demountable. Minimum demounting depth according to installation diagram. The tiles are secured using clips to allow for effective cleaning. The clips are easily removable from above the ceiling. An easy-to-open Connect Inspection hatch is available to simplify access to the ceiling void.



Installation

Installed according to installation diagrams, installation guides and drawing aid. Cut panels must be sealed with Connect Edge sealant.



System weight

The weight of the system (including suspension grid) should be approximately 2,5 kg/m².



Mechanical properties

See table about Max live load and Min load bearing capacity and Functional demands, Mechanical properties at www.ecophon.com.



CE

Ecophon ceiling systems are CE marked according to the European harmonized standard EN13964:2014. CE marked construction products are covered by a Declaration of Performance (DOP) which enables customers and users to easily compare performance of products available on the European market.

INSTALLATION DIAGRAM (M256) FOR ECOPHON HYGIENE MEDITEC™ E

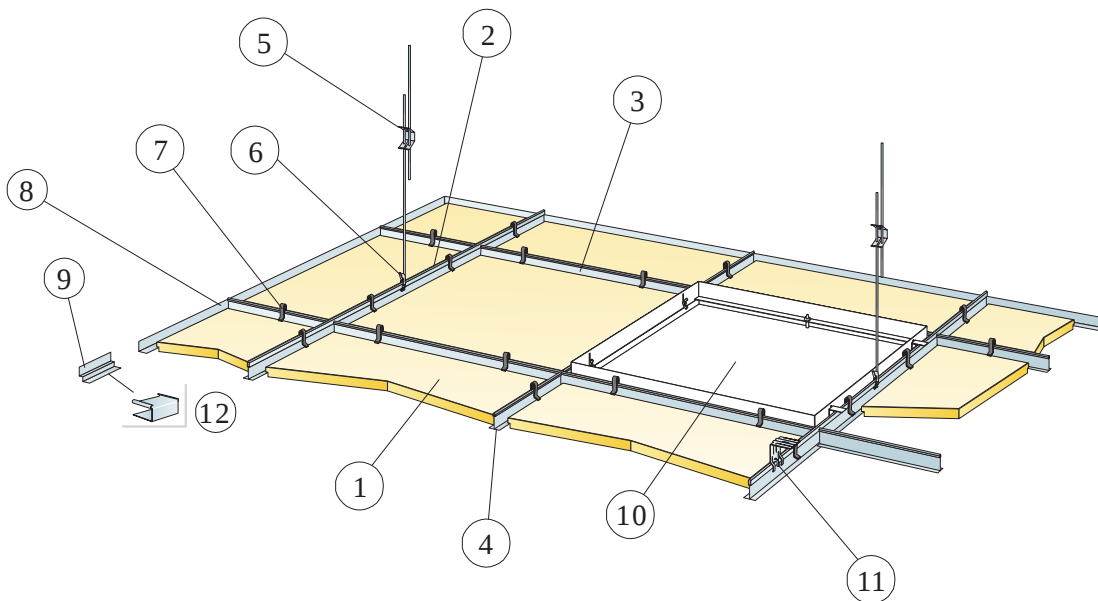

© Saint-Gobain Ecophon AB

QUANTITY SPECIFICATION (EXCL. WASTAGE)

	Size, mm	
	600x600	1200x600
1 Hygiene Meditec E	2,8/m ²	1,4/m ²
2 Connect T24 Main Runner, installed at 1200 mm centres (max distance from wall 300 mm)	0,9m/m ²	0,9m/m ²
3 Connect T24 Cross Tee, L=1200 mm, installed at 600 mm centres	1,7m/m ²	1,7m/m ²
4 Connect T24 Cross Tee, L=600 mm	0,9m/m ²	-
5 Connect Adjustable Hanger, installed at 1200 mm centres (max. distance from wall 600 mm)	0,7/m ²	0,7/m ²
6 Connect Hanger Clip (not to be used in swimming hall environments)	0,7/m ²	0,7/m ²
7 Connect Universal Clip	11/m ²	7/m ²
8 Alt. Connect Angle Trim, fixed c300	as required	as required
9 Alt. Connect Shadow-line Trim, fixed c300	as required	as required
10 Connect Inspection Hatch	as required	as required
11 For direct installation: Connect Direct Bracket, installed at 1200 mm centres	0,7/m ²	0,7/m ²
12 Connect E-plug (for Connect Shadow-line Trim)	as required	as required
Δ Min. overall depth of system, with adjustable hanger and clip: 160 mm, with direct fixing without clip: 60 mm.	-	-
δ Min. demounting depth: With clip: 160 mm. Without clip: 110 mm.	-	-

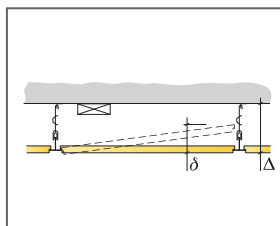

See Quantity Specification

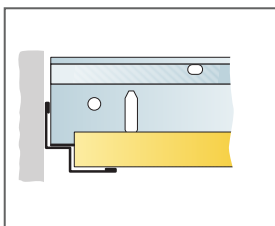

Straight cut and T-profile on top of Connect Shadow-line Trim

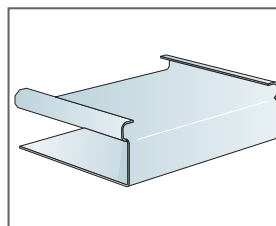

Connect E-plug

Size, mm	Max live load (N)	Min load bearing capacity (N)
600x600x15	50	160
1200x600x15	50	160

Live load/load bearing capacity

Ecophon Hygiene Protec™ A

Ecophon Hygiene Protec™ A has an exposed grid and are particle-repellent for clean rooms, where disinfection and/or cleaning is required on a regular basis. The fully sealed absorbers have low emission levels, ensuring high indoor air quality. They are resistant to mould and bacteria growth.



Unilever Polska, Poland

SYSTEM RANGE

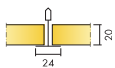

Size, mm	600x600	625x625	1200x600
T24	•	•	•
Thickness (THK)	20	20	20
Inst. Diag.	M257	M257 DIN	M257

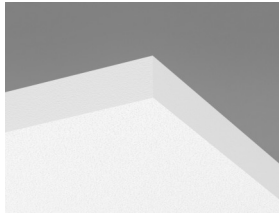

Hygiene Protec A tile

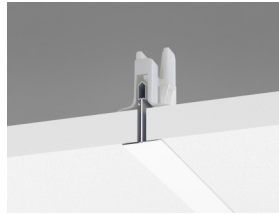

Hygiene Protec A C1 section with Connect Hygiene clip 20



Hygiene Protec A system

Acoustic



Sound Absorption:

Test results according to EN ISO 354. Classification according to EN ISO 11654, and the single value ratings for Noise Reduction Coefficient, NRC and Sound Absorption Average, SAA according to ASTM C 423.

α_p , Practical sound absorption coefficient

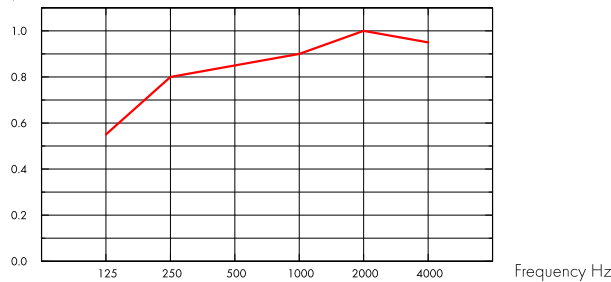

— Hygiene Protec A 20 mm, 200 mm o.d.s.
o.d.s = overall depth of system

THK mm	o.d.s. mm	α_p , Practical sound absorption coefficient						α_w	Sound absorption class
		125 Hz	250 Hz	500 Hz	1000 Hz	2000 Hz	4000 Hz		
20	200	0.55	0.80	0.85	0.90	1.00	0.95	0.90	A

THK mm	o.d.s. mm	NRC	SAA
20	200	0.90	0.89
20	400	0.85	0.84

Indoor Air Quality



Certificate / Label	
Eurofins Indoor Air Comfort®	IAC Gold
French VOC	A+
Finnish M1	•



Cradle to Cradle Certified®



This product is Cradle to Cradle Certified® at Bronze level (version 4.0).



Material Health

This product has received a C2C Certified Material Health Certificate™ at the Silver level (standard version 4.0). The C2C Certified Material Health Certificate™ is a verification of the health and safety of a product's composition using the Material Health requirements of the Cradle-to-Cradle Certified Product Standard.



Circularity

Minimum post-consumer recycled content	44%
Recyclability	Fully recyclable



Fire safety

Country	Class	
Europe	EN 13501-1	A2-s1,d0

The glass wool core of the tiles is tested and classified as non-combustible according to EN ISO 1182.



Humidity Resistance

Class C, relative humidity 95% and 30°C, according to EN 13964:2014



Visual appearance

White 500, nearest NCS colour sample S 0500-N, 84% light reflectance.



Cleanability

Daily dusting and vacuum cleaning. Weekly wet wiping.



Advanced Cleanability

Steam cleaning. Withstand use of hydrogen peroxide vapor.



Surface Endurance

Product tested according to ISO 11998, and withstand 200 cycles.



Chemical resistance/Disinfection

Chemical	Active Substance	Concentration
Ethanol	Ethanol	70%
Chlorine	Sodium Hypochlorite solution	2,5%
Virkon S	Dipotassium peroxodisulphate; Sulphamic acid	1%
Isopropanol	Isopropyl Alcohol	70%

Tested according to ISO 11998 and withstand the following chemicals or disinfectants.



Mould and Bacterial Resistance

Standard/Method	
ISO 846 A	0
ISO 846 C	0



Clean Room

	Standard/Method	Class
ISO 14644	Particle cleanliness class	ISO 3
NF S 90-351	Microbiological class	M1/area 4
NF S 90-351	Particle elimination kinetics	CP(0,5) 1



System weight

The weight of the system (including suspension grid) should be approximately 3-4 kg/m².



Installation

Installed according to installation diagrams, installation guides and drawing aid. Cut panels must be sealed with Connect Edge sealant. Penetrations must be sealed with a suitable sealant.



Accessibility

The tiles are demountable. Minimum demounting depth according to installation diagram. The tiles are secured using clips to allow for effective cleaning. The clips are easily removable from above the ceiling. An easy-to-open Connect Inspection hatch is available to simplify access to the ceiling void.



Mechanical properties

See table about Max live load and Min load bearing capacity and Functional demands, Mechanical properties at www.ecophon.com.



CE

Ecophon ceiling systems are CE marked according to the European harmonized standard EN13964:2014. CE marked construction products are covered by a Declaration of Performance (DOP) which enables customers and users to easily compare performance of products available on the European market.

INSTALLATION DIAGRAM (M257) FOR ECOPHON HYGIENE PROTECT™ A

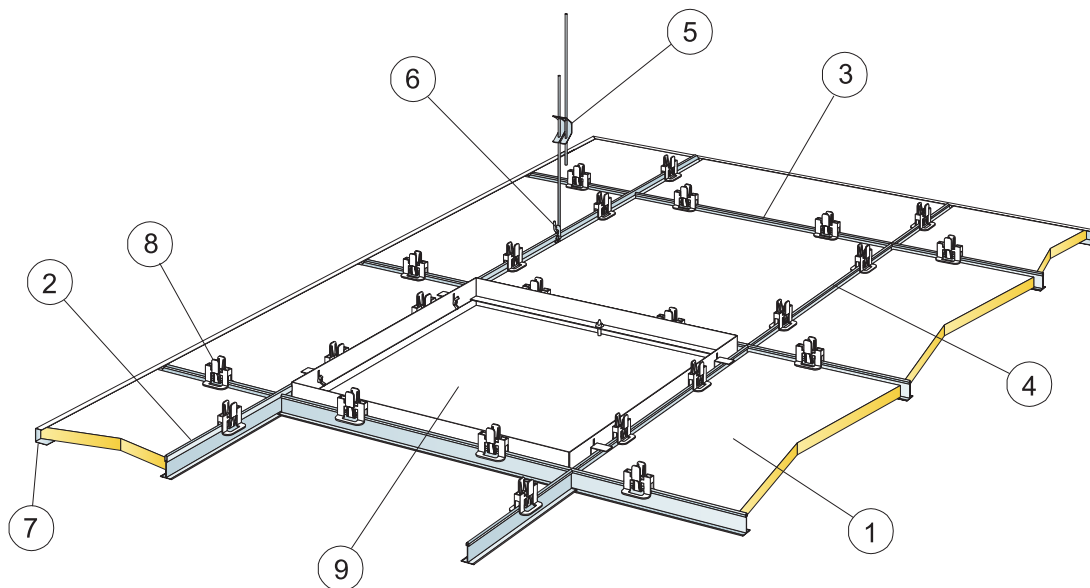

© Saint-Gobain Ecophon AB

QUANTITY SPECIFICATION (EXCL. WASTAGE)

	Size, mm	
	600x600	1200x600
1 Hygiene Protec A	2,8/m ²	1,4/m ²
2 Connect T24 Main Runner, installed at 1200 mm centres (max distance from wall 300 mm)	0,9m/m ²	0,9m/m ²
3 Connect T24 Cross Tee, L=1200 mm, installed at 600 mm centres	1,7m/m ²	1,7m/m ²
4 Connect T24 Cross Tee, L=600 mm	0,9m/m ²	-
5 Connect Adjustable Hanger, installed at 1200 mm centres (max. distance from wall 600 mm)	0,7/m ²	0,7/m ²
6 Connect Hanger Clip (not to be used in swimming hall environments)	0,7/m ²	0,7/m ²
7 Connect Channel Trim, fixed c300	as required	as required
8 Connect Hygiene Clip 20	11/m ²	7/m ²
9 Connect Inspection Hatch	as required	as required
Δ Min. overall depth of system: 150 mm	-	-
δ Min. demounting depth: 150 mm	-	-

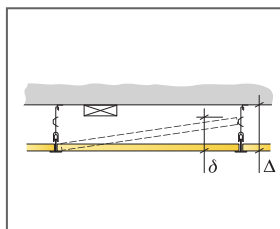

See Quantity Specification

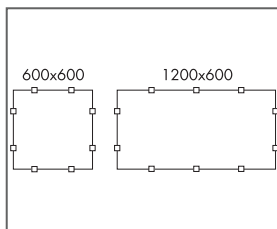

Arrangement of clips

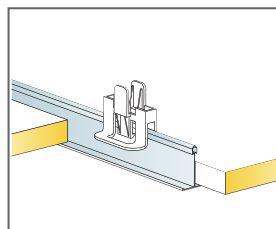

Connect Hygiene Clips for keeping tiles in position

Size, mm	Max live load (N)	Min load bearing capacity (N)
600x600x20	50	160
1200x600x20	50	160

Live load/load bearing capacity

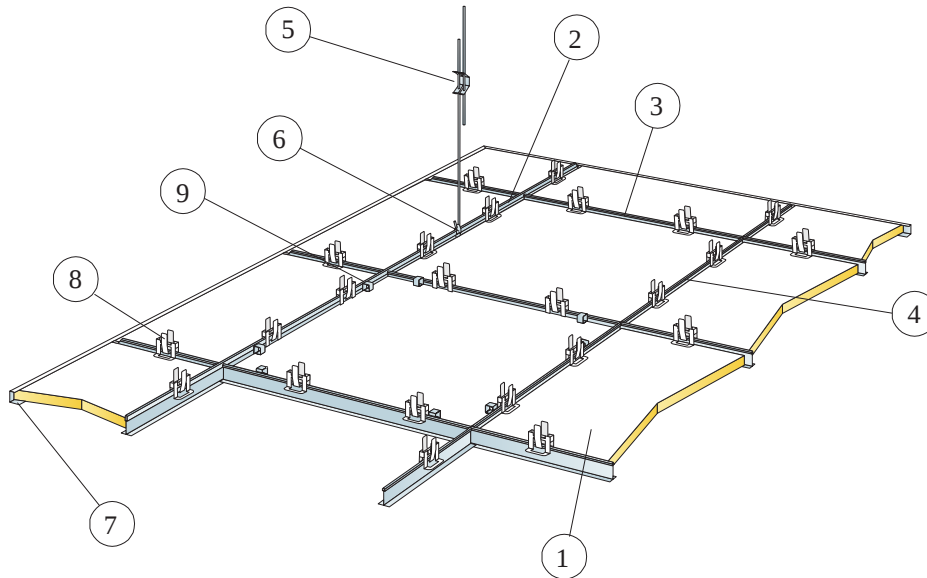

© Saint-Gobain Ecophon AB

QUANTITY SPECIFICATION (EXCL. WASTAGE)

	Size, mm
	625x625
1	2,6/m ²
2 Connect T24 Main Runner, installed at 1250 mm centres	0,8m/m ²
3 Connect T24 Cross Tee, L=1250 mm, installed at 625 mm centres for DIN (only white profiles)	1,6m/m ²
4 Connect T24 Cross Tee, L=625 mm for DIN (only white profiles)	0,8m/m ²
5 Connect Adjustable Hanger, installed at 1250 mm centres (max. distance from wall 600 mm)	0,7/m ²
6 Connect Hanger Clip (not to be used in swimming hall environments)	0,7/m ²
7 Connect Channel Trim, fixed c300	as required
8 Connect Hygiene Clip 20	10/m ²
9 Connect Demo Clip 20 C4, (where access is needed)	as required
Δ Min. overall depth of system: 150 mm	-
δ Min. demounting depth: 150 mm	-

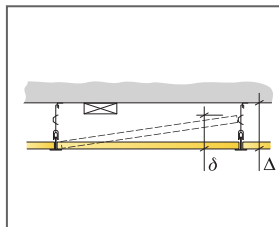

See Quantity Specification

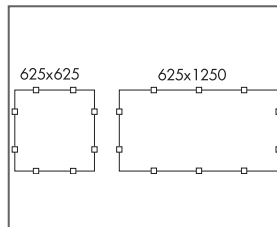

Arrangement of clips

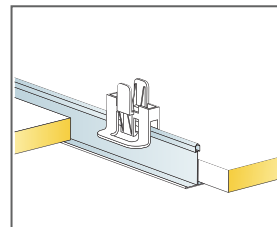

Connect Hygiene Clips for keeping tiles in position

Size, mm	Max live load (N)	Min load bearing capacity (N)
625x625x20	35	160

Live load/load bearing capacity

Ecophon Hygiene Protec™ Ds

Ecophon Hygiene Protec™ Ds has a concealed grid and is particle repellent for clean rooms, where disinfection and/or cleaning is required on a regular basis. The fully sealed absorbers have low emission levels, ensuring high indoor air quality. They are resistant to mould and bacteria growth.



Pharma Labor-Vorbereitung, Greven, Germany

SYSTEM RANGE

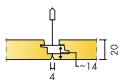

Size, mm	600x600	1200x600
T24	•	•
Thickness (THK)	20	20
Inst. Diag.	M468	M468

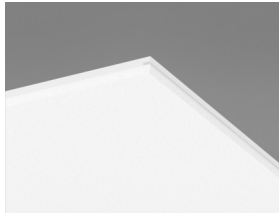

Hygiene Protec Ds tile

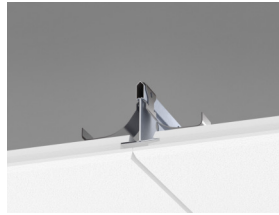

Hygiene Protec Ds C1 section with Connect Hold Down Clip Ds



Sealed junction with wall



Hygiene Protec Ds C1 system

Acoustic



Sound Absorption:

Test results according to EN ISO 354. Classification according to EN ISO 11654, and the single value ratings for Noise Reduction Coefficient, NRC and Sound Absorption Average, SAA according to ASTM C 423.

α_p , Practical sound absorption coefficient

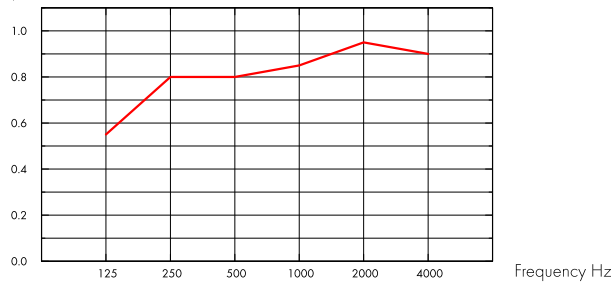

— Hygiene Protec Ds 20 mm, 200 mm o.d.s.
o.d.s = overall depth of system

THK mm	o.d.s. mm	α_p , Practical sound absorption coefficient						α_w	Sound absorption class
		125 Hz	250 Hz	500 Hz	1000 Hz	2000 Hz	4000 Hz		
20	200	0.55	0.80	0.80	0.85	0.95	0.90	0.85	B

THK mm	o.d.s. mm	NRC	SAA
20	200	0.85	0.85

Indoor Air Quality



Certificate / Label	
Eurofins Indoor Air Comfort®	IAC Gold
French VOC	A+
Finnish M1	•



Cradle to Cradle Certified®



This product is Cradle to Cradle Certified® at Bronze level (version 4.0).



Material Health

This product has received a C2C Certified Material Health Certificate™ at the Silver level (standard version 4.0). The C2C Certified Material Health Certificate™ is a verification of the health and safety of a product's composition using the Material Health requirements of the Cradle-to-Cradle Certified Product Standard.



Environmental Footprint

	kg CO ₂ equiv/m ²	Life-cycle stages A1 to C4 from EPD, in conformity with ISO 14025 / EN 15804
Hygiene Protec Ds	7,10	



Circularity

Minimum post-consumer recycled content	47%
Recyclability	Fully recyclable



Fire safety

Country	Class	
Europe	EN 13501-1	A2-s1,d0

The glass wool core of the tiles is tested and classified as non-combustible according to EN ISO 1182.



Humidity Resistance

Class C, relative humidity 95% and 30°C, according to EN 13964:2014



Visual appearance

White 500, nearest NCS colour sample S 0500-N, 84% light reflectance.



Cleanability

Daily dusting and vacuum cleaning. Weekly wet wiping.



Advanced Cleanability

Steam cleaning. Withstand use of hydrogen peroxide vapor.



Surface Endurance

Product tested according to ISO 11998, and withstand 200 cycles.



Chemical resistance/Disinfection

Chemical	Active Substance	Concentration
Ethanol	Ethanol	70%
Chlorine	Sodium Hypochlorite solution	2,5%
Virkon S	Dipotassium peroxodisulphate; Sulphamic acid	1%
Isopropanol	Isopropyl Alcohol	70%

Tested according to ISO 11998 and withstand the following chemicals or disinfectants.



Mould and Bacterial Resistance

Standard/Method	
ISO 846 A	0
ISO 846 C	0



Clean Room

	Standard/Method	Class
ISO 14644	Particle cleanliness class	ISO 3
NF S 90-351	Microbiological class	M1/area 4
NF S 90-351	Particle elimination kinetics	CP(0,5) 1



Accessibility

The tiles are demountable.



Installation

Installed according to installation diagrams, installation guides and drawing aid. Cut panels must be sealed with Connect Edge sealant.



System weight

The weight of the system (including suspension grid) should be approximately 3-4 kg/m².



Mechanical properties

See table about Max live load and Min load bearing capacity and Functional demands, Mechanical properties at www.ecophon.com.



CE

Ecophon ceiling systems are CE marked according to the European harmonized standard EN13964:2014. CE marked construction products are covered by a Declaration of Performance (DOP) which enables customers and users to easily compare performance of products available on the European market.

INSTALLATION DIAGRAM (M468) FOR ECOPHON HYGIENE PROTECT™ DS

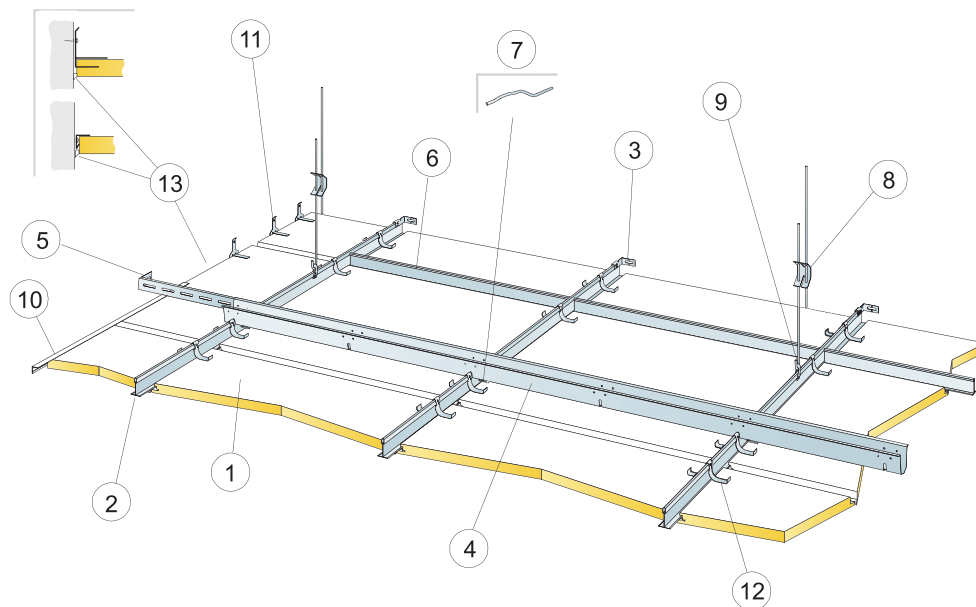

© Saint-Gobain Ecophon AB

QUANTITY SPECIFICATION (EXCL. WASTAGE)

	Size, mm	
	600x600	1200x600
1 Hygiene Protec Ds	2,8/m ²	1,4/m ²
2 Connect T24 Main Runner HD, installed at 600 mm centres	1,7m/m ²	1,7m/m ²
3 Connect Wall Bracket for T-profiles	1/suspended row of Main runner	
4 Connect Space Bar, installed at 1500 mm centres (max. distance from wall 300 mm)	0,7m/m ²	0,7m/m ²
5 Connect Wall Bracket, L=700 mm, for Connect Space Bar	1/row of Space bar	
6 Connect T24 Cross Tee, L=600 mm	2/row of Main runner	
7 Connect Space Bar Winch, installed one per joint Connect Main Runner/Connect Space Bar	1,4/m ²	1,4/m ²
8 Connect Adjustable Hanger, installed at 1200 mm centres (max. distance from wall 600 mm)	0,7/m ²	0,7/m ²
9 Connect Hanger Clip (not to be used in swimming hall environments)	0,7/m ²	0,7/m ²
10 Alt. Connect Frieze Trim, fixed c300 mm	as required	as required
11 Connect Frieze Bracket, installed at 500 mm centre. Minimum free depth above tile 150 mm.	2/cut tile with one bearing edge	3/cut tile with one bearing edge
12 Connect Hold Down Clip Ds	2/tile, 50-100 mm from corners	3/tile, 50-100 mm from corners
13 Joint sealant (not supplied by Ecophon)	as required	as required
Δ Min. overall depth of system: 170 mm	-	-
δ Min. demounting depth: 30 mm	-	-

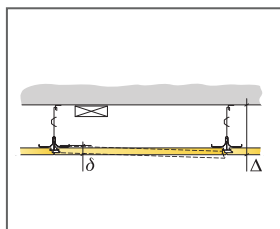

See Quantity Specification

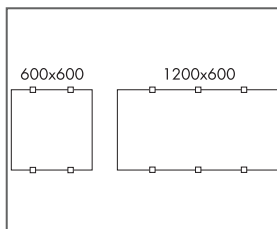

Arrangement of clips

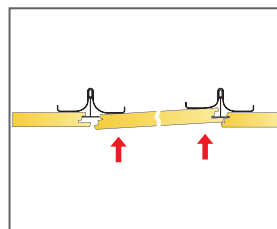

Demounting of tile from below

Size, mm	Max live load (N)	Min load bearing capacity (N)
600x600x20	50	160
1200x600x20	50	160

Live load/load bearing capacity



Ecophon Hygiene Protec™ Air A

Ecophon Hygiene Protec™ Air A has an exposed grid and are particle repellent for clean rooms, where disinfection and/or cleaning is required on a regular basis. Suitable for areas requiring air-pressure control. They are resistant to mould and bacteria growth and withstand HPV cleaning.



Beiersdorf, Hamburg, Germany

SYSTEM RANGE

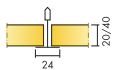

Size, mm	600x600	600x600	1200x600	1200x600
T24	•	•	•	•
Thickness (THK)	20	40	20	40
Inst. Diag.	M469	M469	M469	M469

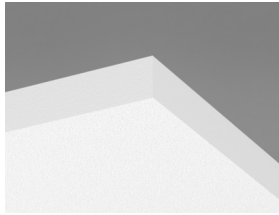

Hygiene Protec Air A tile

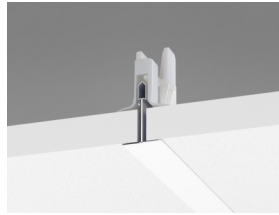

Hygiene Protec Air A C1 section with Connect Hygiene Clip 20



Hygiene Protec Air A C1 system

Acoustic



Sound Absorption:

Test results according to EN ISO 354. Classification according to EN ISO 11654.

α_p , Practical sound absorption coefficient

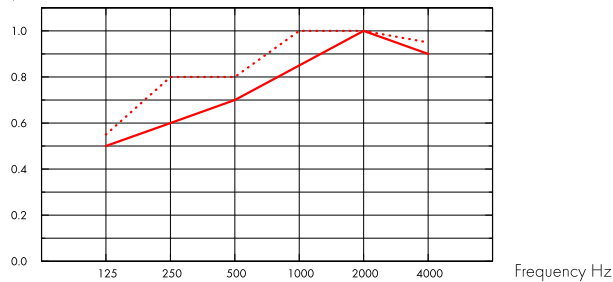

— Hygiene Protec Air A 20 mm, 200 mm o.d.s.

⋯ Hygiene Protec Air A 40 mm, 200 mm o.d.s.

o.d.s = overall depth of system

THK mm	o.d.s. mm	α_p , Practical sound absorption coefficient						α_w	Sound absorption class
		125 Hz	250 Hz	500 Hz	1000 Hz	2000 Hz	4000 Hz		
20	200	0.50	0.60	0.70	0.85	1.00	0.90	0.80	B
40	200	0.55	0.80	0.80	1.00	1.00	0.95	0.90	A

THK mm	o.d.s. mm	NRC	SAA
20	200	0.80	0.81
40	200	0.90	0.92

Indoor Air Quality



Certificate / Label	
Eurofins Indoor Air Comfort®	IAC
French VOC	A
Finnish M1	•



Environmental Footprint



	kg CO ₂ equiv/m ²	Life-cycle stages A1 to C4 from EPD, in conformity with ISO 14025 / EN 15804
Hygiene Protec Air A	4,45	

Circularity



Minimum post-consumer recycled content	38%
Recyclability	Fully recyclable



Fire safety

Country	Class	
Europe	EN 13501-1	A2-s1,d0

The glass wool core of the tiles is tested and classified as non-combustible according to EN ISO 1182.



Humidity Resistance

Class C, relative humidity 95% and 30°C, according to EN 13964:2014



Visual appearance

White 500, nearest NCS colour sample S 0500-N, 84% light reflectance.



Cleanability

Daily dusting and vacuum cleaning. Weekly wet wiping.



Advanced Cleanability

Steam cleaning. Withstand use of hydrogen peroxide vapor.



Surface Endurance

Product tested according to ISO 11998, and withstand 200 cycles.



Chemical resistance/Disinfection

Chemical	Active Substance	Concentration
Ethanol	Ethanol	70%
Chlorine	Sodium Hypochlorite solution	2,5%
Virkon S	Dipotassium peroxodisulphate; Sulphamidic acid	1%
Isopropanol	Isopropyl Alcohol	70%

Tested according to ISO 11998 and withstand the following chemicals or disinfectants.



Mould and Bacterial Resistance

Standard/Method	Class
ISO 846 A	0
ISO 846 C	0



Clean Room

Standard/Method	Class
ISO 14644	Particle cleanliness class ISO 3
NF S 90-351	Microbiological class M1/area 4
NF S 90-351	Particle elimination kinetics CP(0,5) 1



Air permeability

Product	Q50, positive (m ³ /m ² /h)	Q50, positive (l/s/m ²)	Q50, negative (m ³ /m ² /h)	Q50, negative (l/s/m ²)
Hygiene ProtecAir A 20mm	57,7	16,0	36,7	10,2
Hygiene ProtecAir A 40mm	54,3	15,1	47,8	13,3

Measured at positive respective negative room pressure at 50 Pa (Q50) EN ISO 9972 :2015



Accessibility

The tiles are demountable. Minimum demounting depth according to installation diagram. The tiles are secured using clips to allow for effective cleaning. The clips are easily removable from above the ceiling. An easy-to-open Connect Inspection hatch is available to simplify access to the ceiling void.



Installation

Installed according to installation diagrams, installation guides and drawing aid. Cut panels must be sealed with Connect Edge sealant.



System weight

The weight of the system (including suspension grid) should be approximately 3-4 kg/m² for 20mm thickness and 4.5 kg/m² for 40mm thickness.



Mechanical properties

See table about Max live load and Min load bearing capacity and Functional demands, Mechanical properties at www.ecophon.com.



CE

Ecophon ceiling systems are CE marked according to the European harmonized standard EN 13964:2014. CE marked construction products are covered by a Declaration of Performance (DOP) which enables customers and users to easily compare performance of products available on the European market.

INSTALLATION DIAGRAM (M469) FOR ECOPHON HYGIENE PROTECT™ AIR A

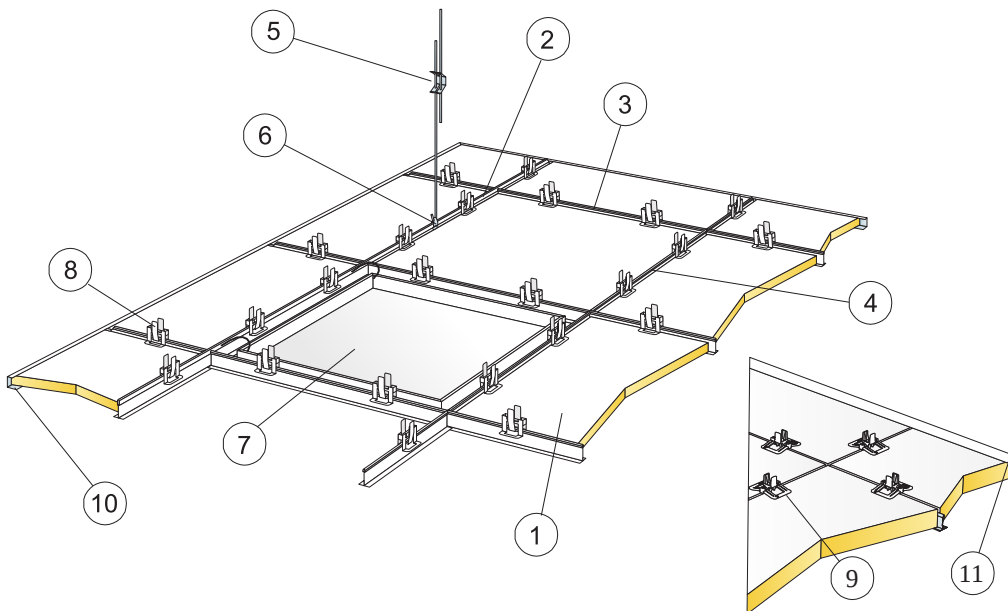

© Saint-Gobain Ecophon AB

QUANTITY SPECIFICATION (EXCL. WASTAGE)

	Size, mm	
	600x600	1200x600
1 Hygiene Protec Air A	2,8/m ²	2,8/m ²
2 Connect T24 Main Runner, installed at 1200 mm centres (max distance from wall 300 mm)	0,9m/m ²	0,9m/m ²
3 Connect T24 Cross Tee, L=1200 mm, installed at 600 mm centres	1,7m/m ²	1,7m/m ²
4 Connect T24 Cross Tee, L=600 mm	0,9m/m ²	0,9m/m ²
5 Connect Adjustable Hanger, installed at 1200 mm centres (max. distance from wall 600 mm)	0,7/m ²	0,7/m ²
6 Connect Hanger Clip (not to be used in swimming hall environments)	0,7/m ²	0,7/m ²
7 Connect Inspection Hatch C3	as required	as required
8 Connect Hygiene Clip 20	11/m ²	11/m ²
9 Connect Hygiene Clip 40	11/m ²	11/m ²
10 Connect Channel Trim, fixed c300 (for 20 mm thickness)	as required	as required
11 Connect Channel Trim, fixed c300 (for 40 mm thickness)	as required	as required
Connect Edge Sealant	as required	as required
Δ Min. overall depth of system: 150 mm	-	-
δ Min. demounting depth 20 mm: 150 mm	-	-
δ Min. demounting depth 40 mm: 170 mm	-	-

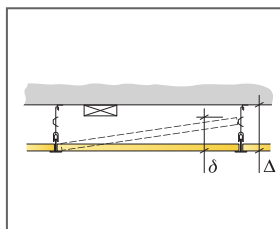

See Quantity Specification

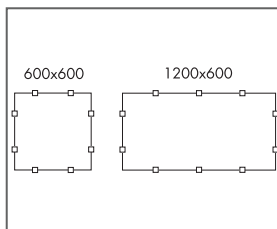

Arrangement of clips

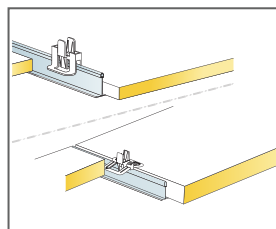

Clip for keeping tiles in place for 20/40 mm tiles

Size, mm	Max live load (N)	Min load bearing capacity (N)
600x600x20	50	160
600x600x40	50	160
1200x600x20	50	160
1200x600x40	50	160

Live load/load bearing capacity

Ecophon Hygiene Performance™ A

Ecophon Hygiene Performance™ A is suitable for humid areas and withstands advanced cleaning, such as steam and high/low pressure washing on a regular basis. The surface is resistant to common detergents and disinfectants.



SYSTEM RANGE

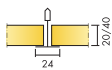

Size, mm	600x600	600x600	1200x600	1200x600
T24	•	•	•	•
Thickness (THK)	20	40	20	40
Inst. Diagr.	M395C3, M266C4	M395C3, M266C4	M395C3, M266C4	M395C3, M266C4

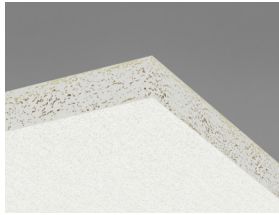

Hygiene Performance A tile

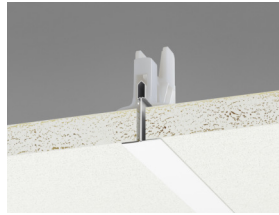

Hygiene Performance A C3 section with Connect Hygiene clip 20



Hygiene Performance A system

Acoustic



Sound Absorption:

Test results according to EN ISO 354. Classification according to EN ISO 11654.

α_p , Practical sound absorption coefficient

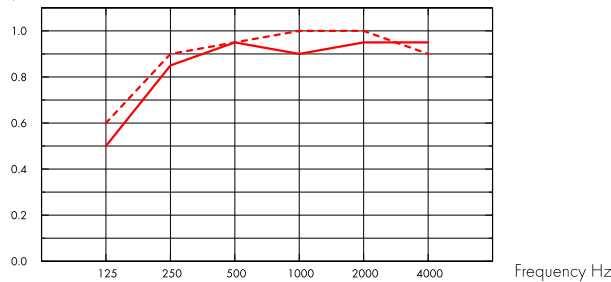

— Hygiene Performance A 20 mm, 200 mm o.d.s.

- - - Hygiene Performance A 40 mm, 200 mm o.d.s.

o.d.s = overall depth of system

THK mm	o.d.s. mm	α_p , Practical sound absorption coefficient						α_w	Sound absorption class
		125 Hz	250 Hz	500 Hz	1000 Hz	2000 Hz	4000 Hz		
20	200	0.50	0.85	0.95	0.90	0.95	0.95	A	
40	200	0.60	0.90	0.95	1.00	1.00	1.00	A	

THK mm	o.d.s. mm	NRC	SAA
20	200	0.90	0.92
40	200	0.95	0.96

Indoor Air Quality



Certificate / Label	
Eurofins Indoor Air Comfort®	IAC Gold
French VOC	A+
Finnish M1	•



Cradle to Cradle Certified®



This product is Cradle to Cradle Certified® at Bronze level (version 4.0).



Material Health

This product has received a C2C Certified Material Health Certificate™ at the Silver level (standard version 4.0). The C2C Certified Material Health Certificate™ is a verification of the health and safety of a product's composition using the Material Health requirements of the Cradle-to-Cradle Certified Product Standard.



Environmental Footprint

	kg CO ₂ equiv/m ²
Hygiene Performance A 20 mm	2,56
Hygiene Performance A 40 mm	4,22

Life-cycle stages A1 to C4 from EPD, in conformity with ISO 14025 / EN 15804



Circularity

Minimum post-consumer recycled content	47%
Recyclability	Fully recyclable



Fire safety

Country	Class	
Europe	EN 13501-1	A2-s1,d0

The glass wool core of the tiles is tested and classified as non-combustible according to EN ISO 1182.



Humidity Resistance

Class D, relative humidity 97% and 50°C, according to EN 13964:2014



Visual appearance

White 500, nearest NCS colour sample S 0500-N, 84% light reflectance.



Cleanability

Daily dusting and vacuum cleaning. Weekly wet wiping.



Advanced Cleanability

High and low pressure cleaning with water and steam cleaning. Withstand use of hydrogen peroxide vapor.



Surface Endurance

Product tested according to ISO 11998, and withstand 200 cycles.



Chemical resistance/Disinfection

Chemical	Active Substance	Concentration
Actichlor plus	NaDCC (Sodium Dichloroisocyanurate)	1%
LifeClean	Chlorine dioxide	Undiluted
Etanol	Etanol	70%
Chlorine	Sodium Hypochlorite solution	2,5%
Virkon S	Sulfamic acid	1%
Isopropanol	Isopropyl Alcohol	70%
Oxivir Excel	Hydrogen peroxide	0,5%
Sumabac D10	Quaternary ammonium compound, Sodium carbonate	1%
Suredis VT1	n-(3-aminopropyl)-n-dodecylpropan-1,3-diamin	1%
Enduro Chlor VE5	Potassium hydroxide	1,5%
Acipusfoam VF59	Nitric Acid	5%

Tested according to ISO 11998 and withstand the following chemicals or disinfectants.



Mould and Bacterial Resistance

Standard/Method	
ISO 846 A	0
ISO 846 C	0



Clean Room

	Standard/Method	Class
ISO 14644	Particle cleanliness class	ISO 4
NF S 90-351	Microbiological class	M1/area 4
NF S 90-351	Particle elimination kinetics	CP(0,5) 5



Accessibility

The tiles are demountable. Minimum demounting depth according to installation diagram. The tiles are secured using clips to allow for effective cleaning. The clips are easily removable from above the ceiling. An easy-to-open Connect Inspection hatch is available to simplify access to the ceiling void.



Installation

Installed according to installation diagrams, installation guides and drawing aid. Cut panels must be sealed with Connect Edge sealant. Penetrations must be sealed with a suitable sealant.



System weight

The weight of the system (including suspension grid) should be approximately 3-4 kg/m² for 20mm thickness and 5 kg/m² for 40mm thickness.



Mechanical properties

See table about Max live load and Min load bearing capacity and Functional demands, Mechanical properties at www.ecophon.com.



CE

Ecophon ceiling systems are CE marked according to the European harmonized standard EN 13964:2014. CE marked construction products are covered by a Declaration of Performance (DOP) which enables customers and users to easily compare performance of products available on the European market.

INSTALLATION DIAGRAM (M395) FOR ECOPHON HYGIENE PERFORMANCE™ A C3

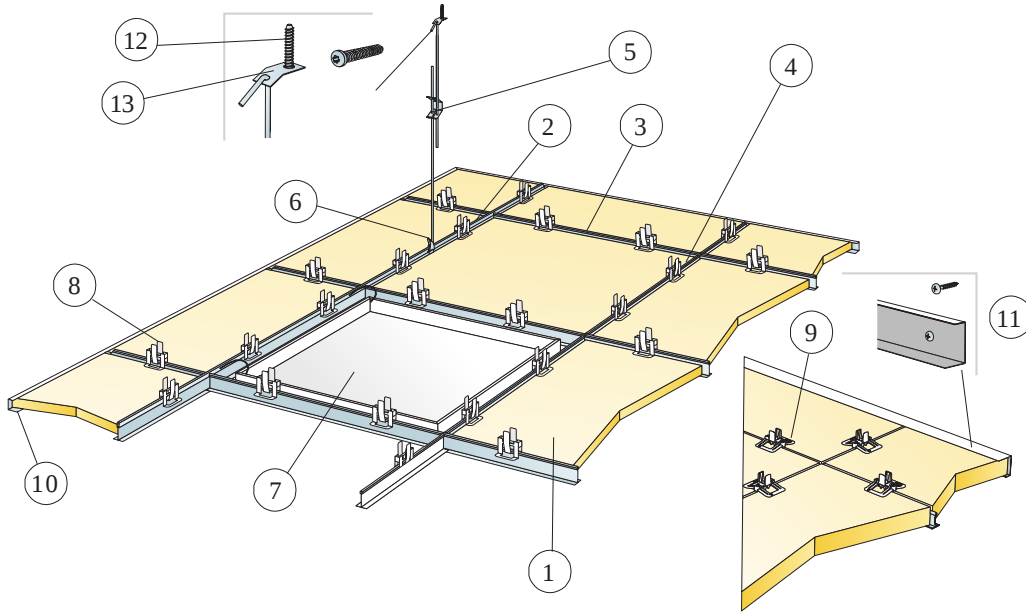

© Saint-Gobain Ecophon AB

QUANTITY SPECIFICATION (EXCL. WASTAGE)

		Size, mm	
		600x600	1200x600
1	Hygiene Performance A	2,8/m ²	2,8/m ²
2	Connect T24 Cross Tee C3, L=600 mm	0,9m/m ²	0,9m/m ²
3	Connect T24 Main Runner C3, installed at 1200 mm centres	0,9m/m ²	0,9m/m ²
4	Connect T24 Cross Tee C3, L=1200 mm, installed at 600 mm centres	1,7m/m ²	1,7m/m ²
5	Connect Adjustable Hanger C3, c1200 (max distance from wall 600 mm)	0,7/m ²	0,7/m ²
6	Connect Hanger Clip (not to be used in swimming hall environments)	0,7/m ²	0,7/m ²
7	Connect Inspection Hatch C3	as required	as required
8	Connect Hygiene Clip 20	11/m ²	11/m ²
9	Connect Hygiene Clip 40	11/m ²	11/m ²
10	Connect Channel Trim C3, fixed c300 (for 20 mm thickness)	as required	as required
11	Connect Channel Trim C3, fixed c300 (for 40 mm thickness)	as required	as required
12	Connect Anchor Screw C4	0,7/m ²	0,7/m ²
13	Connect Fixing Plate C4	0,7/m ²	0,7/m ²
Δ Min. overall depth of system: 150 mm		-	-
δ Min. demounting depth 20 mm: 150 mm		-	-
δ Min. demounting depth 40 mm: 170 mm		-	-

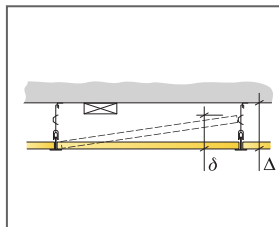

See Quantity Specification

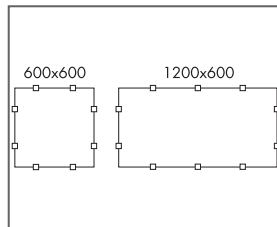

Arrangement of clips

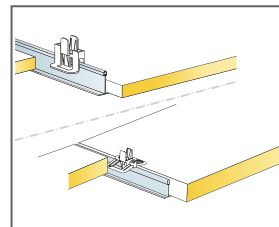

Clip for keeping tiles in place for 20/40 mm tiles

Size, mm	Max live load (N)	Min load bearing capacity (N)
600x600x20	50	160
600x600x40	50	160
1200x600x20	50	160
1200x600x40	50	160

Live load/load bearing capacity

INSTALLATION DIAGRAM (M266C4) FOR ECOPHON HYGIENE PERFORMANCE™ A C4

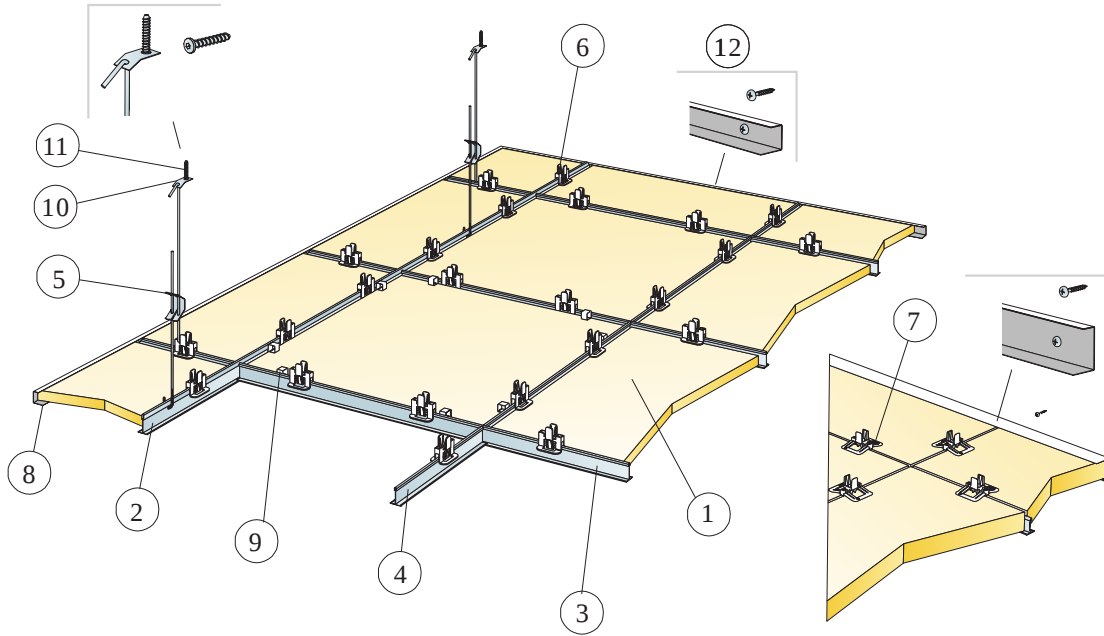

© Saint-Gobain Ecophon AB

QUANTITY SPECIFICATION (EXCL. WASTAGE)

		Size, mm	
		600x600	1200x600
1	Hygiene Performance A	2,8/m ²	2,8/m ²
2	Connect T24 Main Runner C4, c1200	0,9m/m ²	0,9m/m ²
3	Connect T24 Cross Tee C4, L=1200, c600	1,7m/m ²	1,7m/m ²
4	Connect T24 Cross Tee C4, L=600	0,9m/m ²	0,9m/m ²
5	Connect Adjustable Hanger C4, c1200, (max 600 mm distance from wall)	0,7/m ²	0,7/m ²
6	Connect Hygiene Clip 20	11/m ²	11/m ²
7	Connect Hygiene Clip 40 C4	11/m ²	11/m ²
8	Connect Channel Trim C4, fixed at c300 mm	as required	as required
9	Connect Demo Clip 20 C4, (where access is needed)	as required	as required
10	Connect Fixing Plate C4	0,7/m ²	0,7/m ²
11	Connect Anchor Screw C4	0,7/m ²	0,7/m ²
12	Connect Installation Screw C4	3,4/lm Channel trim C4	
Δ Min. overall depth of system: 150 mm		-	-
δ Min. demounting depth: 150 mm		-	-
δ Min. demounting depth 40 mm: 170 mm		-	-

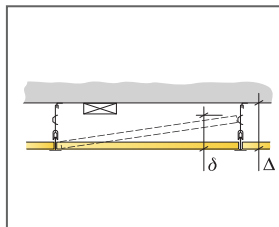

See Quantity Specification

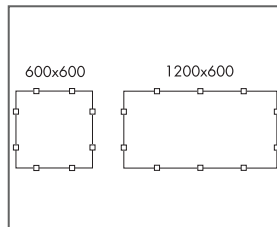

Arrangement of clips

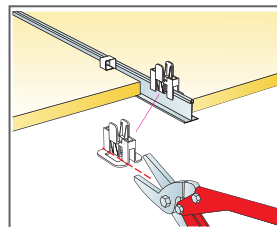

Cutting of Connect Hygiene Clip 20 at the inspection tile

Size, mm	Max live load (N)	Min load bearing capacity (N)
600x600x20	50	160
600x600x40	50	160
1200x600x20	50	160
1200x600x40	50	160

Live load/load bearing capacity



Ecophon Hygiene Performance™ Ds

Ecophon Hygiene Performance™ Ds is a suspended ceiling with a concealed grid, where individual tiles must be easily demountable. Suitable for swimming pool areas, it's compatible in areas with high humidity, corrosivity and occasional direct water.



SYSTEM RANGE

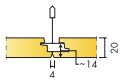

Size, mm	600x600	1200x600
T24	•	•
Thickness (THK)	20	20
Inst. Diag.	M439C4	M439C4

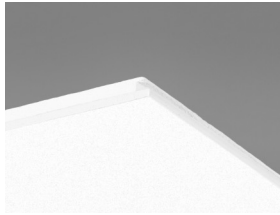

Performance Ds tile

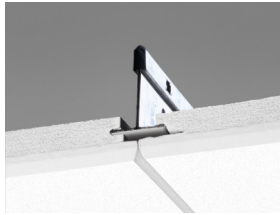

Section of Performance Ds system with Connect T24 Main Runner C4

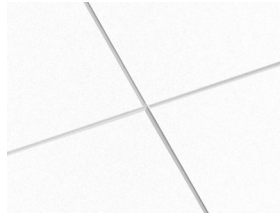

Performance Ds system



The individual tiles are easily demountable

Acoustic



Sound Absorption:

Test results according to EN ISO 354. Classification according to EN ISO 11654.

α_p , Practical sound absorption coefficient

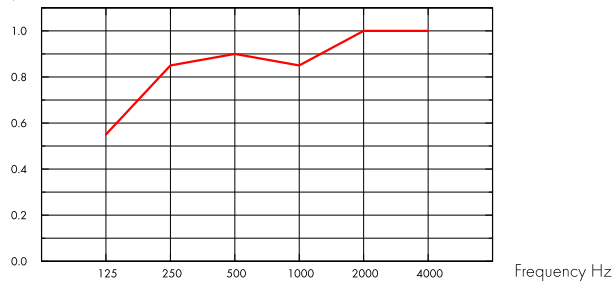

— Hygiene Performance Ds 20 mm, 200 mm o.d.s.

o.d.s = overall depth of system

THK mm	o.d.s. mm	α_p , Practical sound absorption coefficient						α_w	Sound absorption class
		125 Hz	250 Hz	500 Hz	1000 Hz	2000 Hz	4000 Hz		
20	200	0.55	0.85	0.90	0.85	1.00	1.00	0.90	A

THK mm	o.d.s. mm	NRC	SAA
20	200	0.90	0.91

Indoor Air Quality



Certificate / Label	
Eurofins Indoor Air Comfort®	IAC Gold
French VOC	A+
Finnish M1	•



Environmental Footprint



	kg CO ₂ equiv/m ²
Hygiene Performance Ds	4,5

Life-cycle stages A1 to C4 from EPD, in conformity with ISO 14025 / EN 15804

Circularity



Minimum post-consumer recycled content	54%
Recyclability	Fully recyclable

Fire safety



Country	Class
Europe	EN 13501-1 A2-s1,d0

The glass wool core of the tiles is tested and classified as non-combustible according to EN ISO 1182.



Humidity Resistance

Class C, relative humidity 95% and 30°C, according to EN 13964:2014



Visual appearance

White 500, nearest NCS colour sample S 0500-N, 84% light reflectance.



Cleanability

Daily dusting and vacuum cleaning. Weekly wet wiping.



Advanced Cleanability

Steam cleaning. Withstand use of hydrogen peroxide vapor.



Surface Endurance

Product tested according to ISO 11998, and withstand 200 cycles.



Mould and Bacterial Resistance

Standard/Method	
ISO 846 A	0
ISO 846 C	0



Chemical resistance/Disinfection

Chemical	Active Substance	Concentration
Actichlor plus	NaDCC (Sodium Dichloroisocyanurate)	1%
LifeClean	Chlorine dioxide	Undiluted
Etanol	Etanol	70%
Chlorine	Sodium Hypochlorite solution	2,5%
Virkon S	Sulfamic acid	1%
Isopropanol	Isopropyl Alcohol	70%
Oxivir Excel	Hydrogen peroxide	0,5%
Sumabac D10	Quaternary ammonium compound, Sodium carbonate	1%
Suredis VT1	n-(3-aminopropyl)-n-dodecylpropan-1,3-diamin	1%
Enduro Chlor VE5	Potassium hydroxide	1,5%
Aciplusfoam VF59	Nitric Acid	5%

Tested according to ISO 11998 and withstand the following chemicals or disinfectants.



Clean Room

	Standard/Method	Class
ISO 14644	Particle cleanliness class	ISO 4
NF S 90-351	Microbiological class	M1/area 4
NF S 90-351	Particle elimination kinetics	CP(0,5) 5



Accessibility

The tiles are demountable.



Installation

Installed according to installation diagrams, installation guides and drawing aid. Cut panels must be sealed with Connect Edge sealant. Penetrations must be sealed with a suitable sealant.



System weight

The weight of the system (including suspension grid) should be approximately 3-4 kg/m².



Mechanical properties

See table about Max live load and Min load bearing capacity and Functional demands, Mechanical properties at www.ecophon.com.



CE

Ecophon ceiling systems are CE marked according to the European harmonized standard EN13964:2014. CE marked construction products are covered by a Declaration of Performance (DOP) which enables customers and users to easily compare performance of products available on the European market.

INSTALLATION DIAGRAM (M439C4) FOR ECOPHON PERFORMANCE™ DS C4

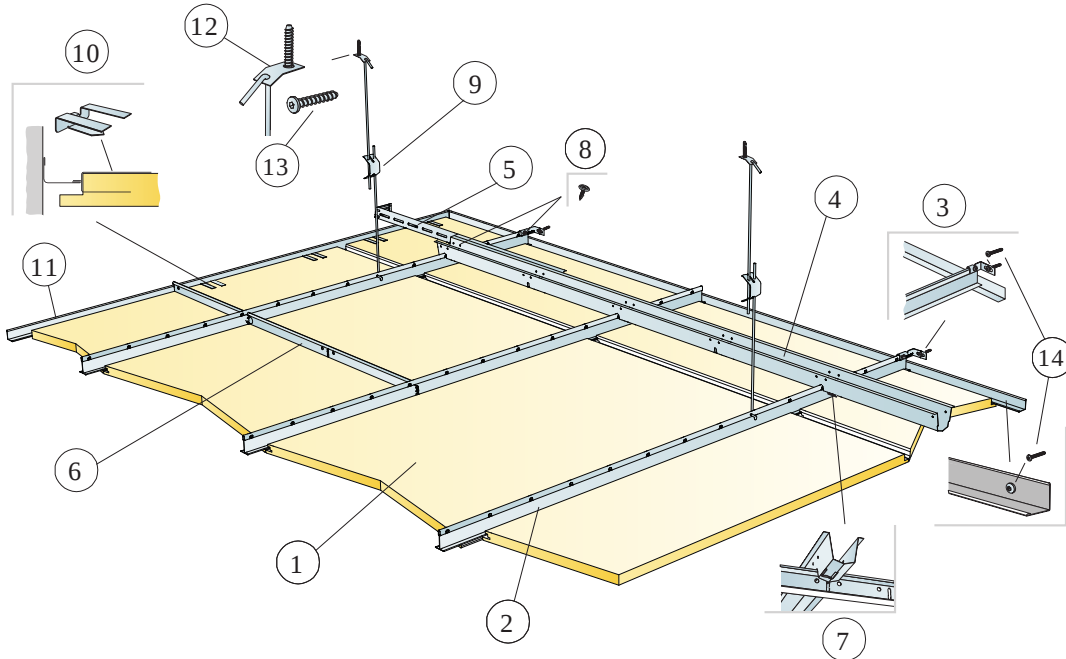

© Saint-Gobain Ecophon AB

QUANTITY SPECIFICATION (EXCL. WASTAGE)

	Size, mm	
	600x600	1200x600
1 Hygiene Performance Ds	2,8/m ²	1,4/m ²
2 Connect T24 Main Runner C4, installed at 600 mm centres	1,7/m ²	1,7/m ²
3 Connect Wall Bracket C4 for T-profiles C4	1/suspended row of Main runner	
4 Connect Space Bar C4, installed at 1500 mm centres (max. distance from wall 300 mm) for winch	0,7/m ²	0,7/m ²
5 Connect Wall Bracket C4, L=700 mm, for Connect Space Bar	1/row of Space bar	
6 Connect T24 Cross Tee C4, L=600 mm	2/row of Main runner	
7 Connect Space Bar Winch C4, installed one per joint Connect Main Runner/Connect Space Bar	1,4/m ²	1,4/m ²
8 C4 screw for wall brackets(included in products)	-	-
9 Connect Adjustable Hanger C4, installed at 1200 mm centres (max. distance from wall 600 mm)	0,7/m ²	0,7/m ²
10 Connect Support Clip Dg20 C4	1 pc/300-400 mm on every cut perimeter tile with only 1 supporting edge	
11 Connect Angle Trim 15/22 C4, fixed at 300 mm centres	as required	as required
12 Connect Fixing Plate C4	0,7/m ²	0,7/m ²
13 Connect Anchor Screw C4	0,7/m ²	0,7/m ²
14 Connect Installation Screw C4	3,4/lm Channel trim C4	
Δ Min. overall depth of system: 385 mm	-	-
δ Min. demounting depth: 30 mm	-	-

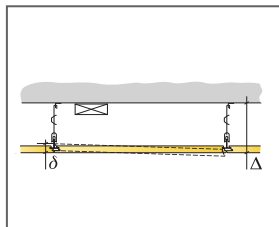

See Quantity Specification

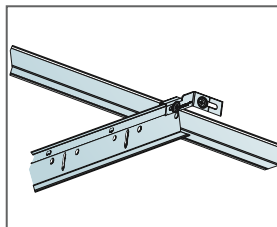

Secured Connect Main Runner C4 at wall with Connect Wall Bracket C4

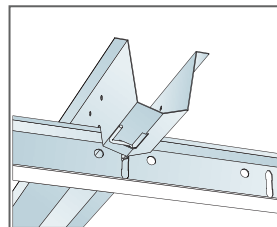

Connection between profiles and Connect Space Bar Winch C4

Size, mm	Max live load (N)	Min load bearing capacity (N)
600x600x20	50	160
1200x600x20	50	160

Live load/load bearing capacity



Ecophon Hygiene Performance™ Plus A

Ecophon Hygiene Performance™ Plus A has an exposed grid with fully sealed robust Hygiene Performance™ Plus A tiles and suitable for humid areas. The ceiling withstands advanced cleaning, such as steam and high/low pressure washing on a regular basis. The surface is resistant to common detergents and disinfectants.



Oatly, Landstona, Sweden

SYSTEM RANGE

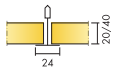

Size, mm	600x600	600x600	1200x600	1200x600
T24	•	•	•	•
Thickness (THK)	20	40	20	40
Inst. Diag.	M466	M466	M466	M466

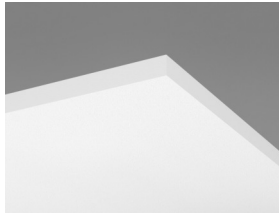

Hygiene Performance Plus A tile

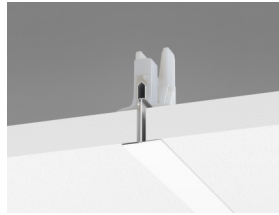

Hygiene Performance Plus A C3 section with Connect Hygiene Clip 20



Hygiene Performance Plus A system

Acoustic



Sound Absorption:

Test results according to EN ISO 354. Classification according to EN ISO 11654, and the single value ratings for Noise Reduction Coefficient, NRC and Sound Absorption Average, SAA according to ASTM C 423.

α_p , Practical sound absorption coefficient

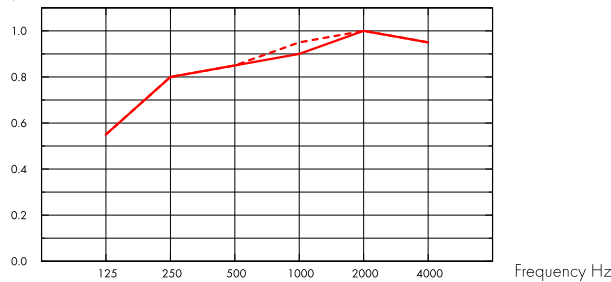

- Hygiene Performance Plus A 20 mm, 200 mm o.d.s.
 - - - Hygiene Performance Plus A 40 mm, 200 mm o.d.s.
- o.d.s = overall depth of system

THK mm	o.d.s. mm	α_p , Practical sound absorption coefficient						α_w	Sound absorption class
		125 Hz	250 Hz	500 Hz	1000 Hz	2000 Hz	4000 Hz		
20	200	0.55	0.80	0.85	0.90	1.00	0.95	0.90	A
40	200	0.55	0.80	0.85	0.95	1.00	0.95	0.95	A

THK mm	o.d.s. mm	NRC	SAA
20	200	0.90	0.89
40	200	0.90	0.90

Indoor Air Quality



Certificate / Label	
Eurofins Indoor Air Comfort®	IAC
French VOC	A
Finnish M1	•



Cradle to Cradle Certified®



This product is Cradle to Cradle Certified® at Bronze level (version 4.0).



Material Health

This product has received a C2C Certified Material Health Certificate™ at the Silver level (standard version 4.0). The C2C Certified Material Health Certificate™ is a verification of the health and safety of a product's composition using the Material Health requirements of the Cradle-to-Cradle Certified Product Standard.



Environmental Footprint

	kg CO ₂ equiv/m ²
Hygiene Performance Plus A, 20mm	3,22
Hygiene Performance Plus A, 40mm	5,19

Life-cycle stages A1 to C4 from EPD, in conformity with ISO 14025 / EN 15804



Circularity

Minimum post-consumer recycled content	44%
Recyclability	Fully recyclable



Fire safety

Country	Class	
Europe	EN 13501-1	A2-s1,d0

The glass wool core of the tiles is tested and classified as non-combustible according to EN ISO 1182.



Humidity Resistance

Class D, relative humidity 97% and 50°C, according to EN 13964:2014



Visual appearance

White 500, nearest NCS colour sample S 0500-N, 84% light reflectance.



Cleanability

Daily dusting and vacuum cleaning. Weekly wet wiping.



Advanced Cleanability

High and low pressure cleaning with water and steam cleaning. Withstand use of hydrogen peroxide vapor.



Surface Endurance

Product tested according to ISO 11998, and withstand 200 cycles.



Chemical resistance/Disinfection

Chemical	Active Substance	Concentration
Actichlor plus	NaDCC (Sodium Dichloroisocyanurate)	1%
LifeClean	Chlorine dioxide	Undiluted
Etanol	Etanol	70%
Chlorine	Sodium Hypochlorite solution	2,5%
Virkon S	Sulfamic acid	1%
Isopropanol	Isopropyl Alcohol	70%
Oxivir Excel	Hydrogen peroxide	0,5%
Sumabac D10	Quaternary ammonium compound, Sodium carbonate	1%
Suredis VT1	n-(3-aminopropyl)-n-dodecylpropan-1,3-diamin	1%
Enduro Chlor VE5	Potassium hydroxide	1,5%
Acipusfoam VF59	Nitric Acid	5%

Tested according to ISO 11998 and withstand the following chemicals or disinfectants.



Mould and Bacterial Resistance

Standard/Method	
ISO 846 A	0
ISO 846 C	0



Clean Room

	Standard/Method	Class
ISO 14644	Particle cleanliness class	ISO 4
NF S 90-351	Microbiological class	M1/area 4
NF S 90-351	Particle elimination kinetics	CP(0,5) 5



Accessibility

The tiles are demountable. Minimum demounting depth according to installation diagram. The tiles are secured using clips to allow for effective cleaning. The clips are easily removable from above the ceiling. An easy-to-open Connect Inspection hatch is available to simplify access to the ceiling void.



System weight

The weight of the system (including suspension grid) should be approximately 3,5 kg/m² for 20mm thickness and 5 kg/m² for 40mm thickness.



Mechanical properties

See table about Max live load and Min load bearing capacity and Functional demands, Mechanical properties at www.ecophon.com.



CE

Ecophon ceiling systems are CE marked according to the European harmonized standard EN13964:2014. CE marked construction products are covered by a Declaration of Performance (DOP) which enables customers and users to easily compare performance of products available on the European market.

INSTALLATION DIAGRAM (M466) FOR ECOPHON HYGIENE PERFORMANCE™ PLUS A C3

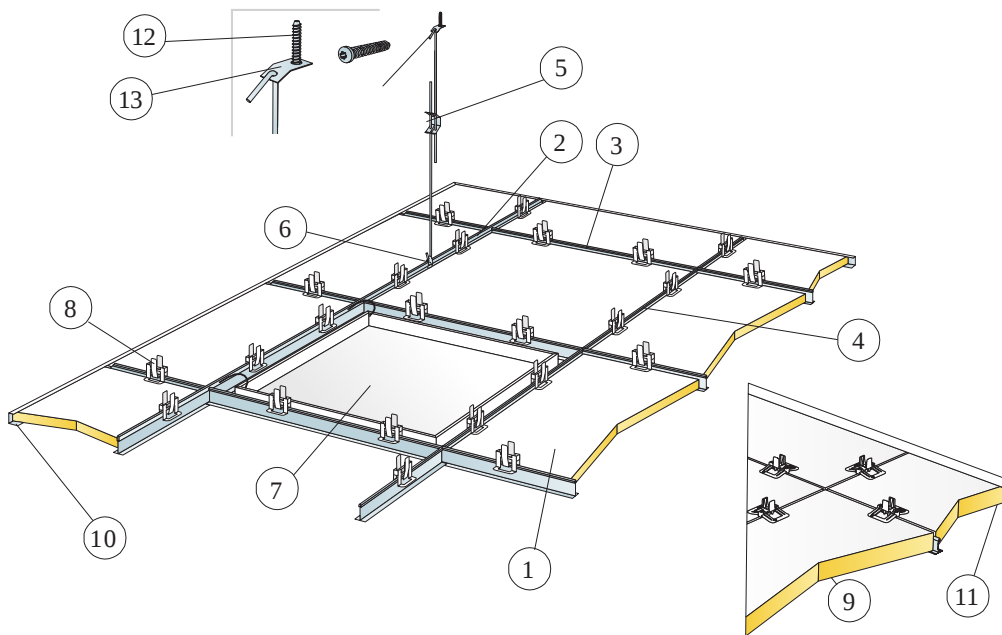

© Saint-Gobain Ecophon AB

QUANTITY SPECIFICATION (EXCL. WASTAGE)

		Size, mm	
		600x600	1200x600
1	Hygiene Performance Plus A	2,8/m ²	2,8/m ²
2	Connect T24 Main Runner C3, installed at 1200 mm centres	0,9m/m ²	0,9m/m ²
3	Connect T24 Cross Tee C3, L=1200 mm, installed at 600 mm centres	1,7m/m ²	1,7m/m ²
4	Connect T24 Cross Tee C3, L=600 mm	0,9m/m ²	0,9m/m ²
5	Connect Adjustable Hanger C3, c1200 (max distance from wall 600 mm)	0,7/m ²	0,7/m ²
6	Connect Hanger Clip (not to be used in swimming hall environments)	0,7/m ²	0,7/m ²
7	Connect Inspection Hatch C3	as required	as required
8	Connect Hygiene Clip 20	11/m ²	11/m ²
9	Connect Hygiene Clip 40	11/m ²	11/m ²
10	Connect Channel Trim C3, fixed c300 (for 20 mm thickness)	as required	as required
11	Connect Channel Trim C3, fixed c300 (for 40 mm thickness)	as required	as required
12	Connect Anchor Screw C4	0,7/m ²	0,7/m ²
13	Connect Fixing Plate C4	0,7/m ²	0,7/m ²
Δ Min. overall depth of system: 150 mm		-	-
δ Min. demounting depth 20 mm: 150 mm		-	-
δ Min. demounting depth 40 mm: 170 mm		-	-

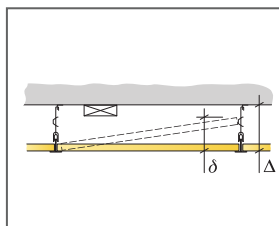

See Quantity Specification

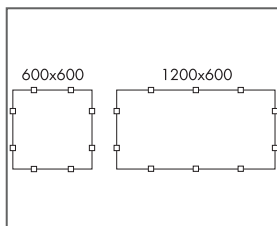

Arrangement of clips

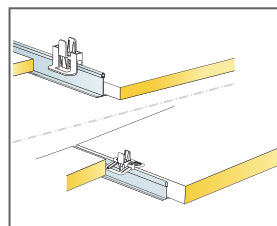

Clip for keeping tiles in place for 20/40 mm tiles

Size, mm	Max live load (N)	Min load bearing capacity (N)
600x600x20	50	160
600x600x40	50	160
1200x600x20	50	160
1200x600x40	50	160

Live load/load bearing capacity



Ecophon Hygiene Performance™ Baffle

Ecophon Hygiene Performance™ Baffle is an easy to clean, sound absorbing system with vertical baffles suitable for humid areas. The baffles withstand advanced cleaning, such as steam and high/low pressure washing on a regular basis.



SYSTEM RANGE



Size, mm	1200x600
T24	•
Thickness (THK)	50
Inst. Diag.	M494C4, M492C3, M493C3

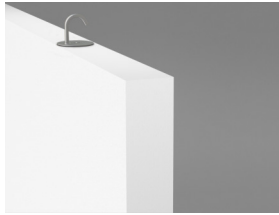

Solo Baffle/hook

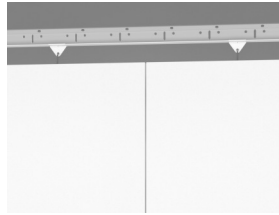

Hygiene Performance Baffle C4

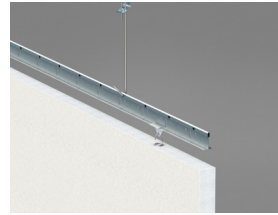

Hygiene Performance Baffle C4 installation

Acoustic



Sound Absorption:

Test results according to EN ISO 354:2003 NOTE: Results shown are not comparable with results according to older versions of this standard due to discrepancies in test method. Classification according to EN ISO 11654, and the single value ratings for Noise Reduction Coefficient, NRC and Sound Absorption Average, SAA according to ASTM C 423.

α_p , Practical sound absorption coefficient

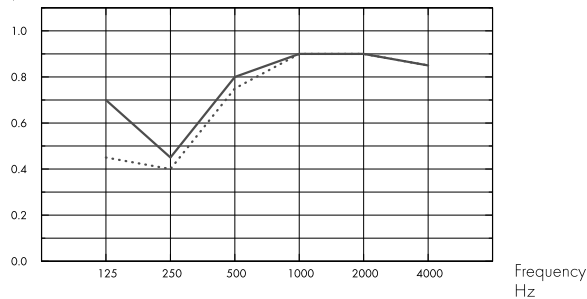

.... Performance Baffle oriented in rows, c600 mm, with ~1,4 baffles/m² ceiling area, 600 mm o.d.s.

– Performance Baffle oriented in rectangles, with ~1,3 baffles/m² ceiling area, 600 mm o.d.s.

o.d.s = overall depth of system

	THK mm	o.d.s. mm	α_p , Practical sound absorption coefficient					α_w	Sound absorption class	
			125 Hz	250 Hz	500 Hz	1000 Hz	2000 Hz			4000 Hz
in rows	50	600	0.45	0.40	0.75	0.90	0.90	0.85	0.70	C
in rectangles	50	600	0.70	0.45	0.80	0.90	0.90	0.85	0.75	C

THK mm	o.d.s. mm	NRC	SAA
50	600	0.75	0.73
50	600	0.75	0.77

Indoor Air Quality



Certificate / Label

Eurofins Indoor Air Comfort®

IAC

French VOC

A

Finnish M1

•



Cradle to Cradle Certified®



This product is Cradle to Cradle Certified® at Bronze level (version 4.0).



Material Health

This product has received a C2C Certified Material Health Certificate™ at the Silver level (standard version 4.0). The C2C Certified Material Health Certificate™ is a verification of the health and safety of a product's composition using the Material Health requirements of the Cradle-to-Cradle Certified Product Standard.



Environmental Footprint

	kg CO ₂ equiv/m ²
Hygiene Performance Baffle	8,30

Life-cycle stages A1 to C4 from EPD, in conformity with ISO 14025 / EN 15804



Circularity

Minimum post-consumer recycled content	57%
Recyclability	Fully recyclable



Fire safety

Country	Class	
Europe	EN 13501-1	A2-s1,d0

The glass wool core of the tiles is tested and classified as non-combustible according to EN ISO 1182.



Humidity Resistance

Class C, relative humidity 95% and 30°C, according to EN 13964:2014



Visual appearance

White 500, nearest NCS colour sample S 0500-N, 84% light reflectance.



Cleanability

Daily dusting and vacuum cleaning. Weekly wet wiping.



Advanced Cleanability

Low pressure cleaning with water and steam cleaning. Products, once demounted, can be high pressure cleaned according to Ecophon high pressure cleaning protocol. Withstand use of hydrogen peroxide vapor.



Surface Endurance

Product tested according to ISO 11998, and withstand 200 cycles.



Chemical resistance/Disinfection

Chemical	Active Substance	Concentration
Actichlor plus	NaDCC (Sodium Dichloroisocyanurate)	1%
LifeClean	Chlorine dioxide	Undiluted
Etanol	Etanol	70%
Chlorine	Sodium Hypochlorite solution	2,5%
Virkon S	Sulfamic acid	1%
Isopropanol	Isopropyl Alcohol	70%
Oxivir Excel	Hydrogen peroxide	0,5%
Sumabac D10	Quaternary ammonium compound, Sodium carbonate	1%
Suredis VT1	n-(3-aminopropyl)-n-dodecylpropan-1,3-diamin	1%
Enduro Chlor VE5	Potassium hydroxide	1,5%
Aciplusfoam VF59	Nitric Acid	5%

Tested according to ISO 11998 and withstand the following chemicals or disinfectants.



Mould and Bacterial Resistance

Standard/Method	
ISO 846 A	0
ISO 846 C	0



Clean Room

	Standard/Method	Class
ISO 14644	Particle cleanliness class	ISO 4
NF S 90-351	Microbiological class	M1/area 4
NF S 90-351	Particle elimination kinetics	CP(0,5) 5



Accessibility

The tiles are demountable.



Installation

Installed according to installation diagrams, installation guides and drawing aid. Cut panels must be sealed with Connect Edge sealant.



System weight

The weight of the system (including suspension grid) should be approximately 5 kg/m².



Mechanical properties

Please observe that vibrations, airflow and other types of mechanical impact can affect the mechanical properties of the fixings.



CE

Ecophon ceiling systems are CE marked according to the European harmonized standard EN 13964:2014. CE marked construction products are covered by a Declaration of Performance (DOP) which enables customers and users to easily compare performance of products available on the European market.

INSTALLATION DIAGRAM (M494C4) FOR ECOPHON HYGIENE PERFORMANCE™ Baffle C4 (IN ROWS)

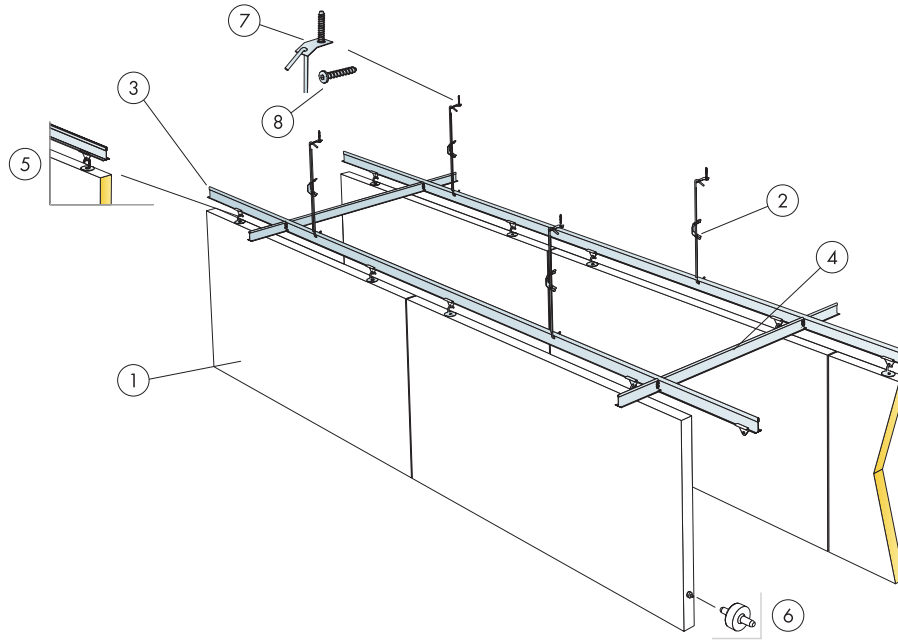

© Saint-Gobain Ecophon AB

QUANTITY SPECIFICATION (EXCL. WASTAGE)

		Size, mm
		1200x600
1	Hygiene Performance Baffle	1,4/m ²
2	Connect Adjustable Hanger C4 c1200	1,4/m ²
3	Connect T24 Main Runner C4, installed at 600 mm centres	1,7m/m ²
4	Connect T24 Cross Tee C4, L=600 mm, installed at 1800 mm centres	0,6m/m ²
5	Connect Baffle Clip C4	2,8/m ²
6	Connect Guiding Pin, installed at 1200/1800 mm centres	2,8/m ²
7	Connect Fixing Plate C4	1,4/m ²
8	Connect Anchor Screw C4	1,4/m ²

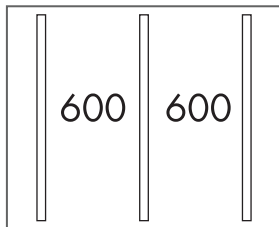

Installation in rows

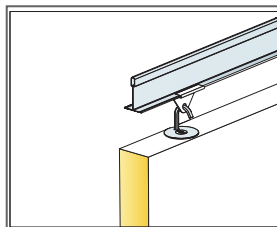

Detail of suspension

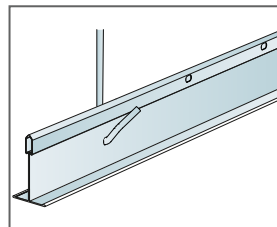

Suspension with Connect Adjustable Hanger C4

Size, mm	Max live load (N)	Min load bearing capacity (N)
1200x600x50	0	160

Live load/load bearing capacity

INSTALLATION DIAGRAM (M492C3) FOR ECOPHON HYGIENE PERFORMANCE™ Baffle C3 (IN ROWS)

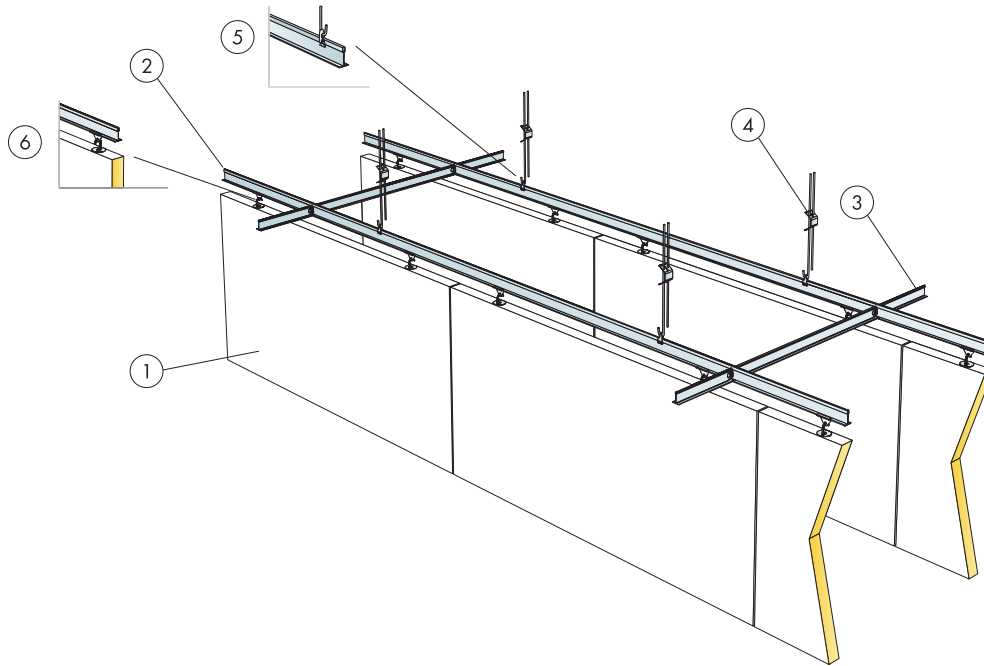

© Saint-Gobain Ecophon AB

QUANTITY SPECIFICATION (EXCL. WASTAGE)

		Size, mm
		1200x600
1	Hygiene Performance Baffle	1,4/m ²
2	Connect T24 Main Runner C3, installed at 600 mm centres	1,7m/m ²
3	Connect T24 Cross Tee C3, L=600 mm, installed at 1800 mm centres	0,6m/m ²
4	Connect Adjustable Hanger C3 c1200	1,4/m ²
5	Connect Hanger Clip	1,4/m ²
6	Connect Baffle Clip C3	2,8/m ²

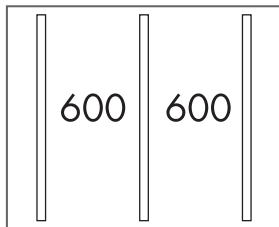

Installation in rows

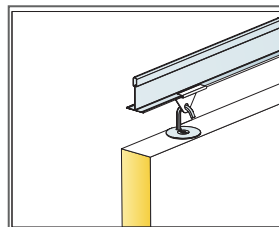

Detail of suspension

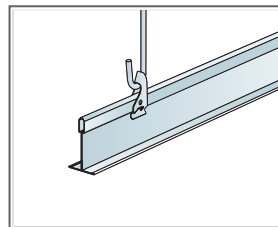

Suspension with Connect Adjustable Hanger and Connect Hanger Clip

Size, mm	Max live load (N)	Min load bearing capacity (N)
1200x600x50	0	160

Live load/load bearing capacity

INSTALLATION DIAGRAM (M493C3) FOR ECOPHON HYGIENE PERFORMANCE™ Baffle C3 (IN RECTANGLES)

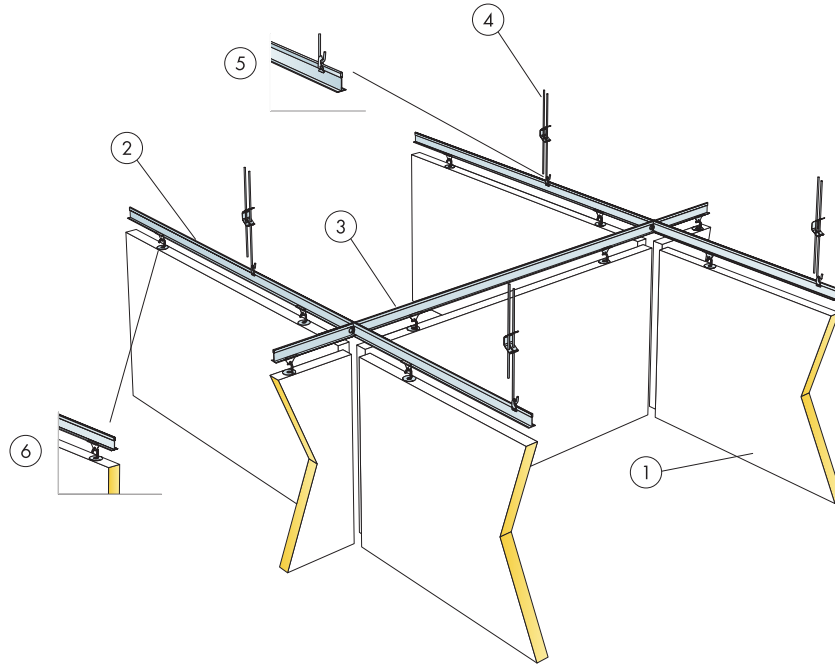

© Saint-Gobain Ecophon AB

QUANTITY SPECIFICATION (EXCL. WASTAGE)

		Size, mm
		1200x600
1	Hygiene Performance Baffle	1,3/m ²
2	Connect T24 Main Runner C3, installed at 1250 mm centres	0,8m/m ²
3	Connect T24 Cross Tee C3, L=1250 mm, installed at 1300 mm centres	0,8m/m ²
4	Connect Adjustable Hanger C3	0,7/m ²
5	Connect Hanger Clip	0,7/m ²
6	Connect Baffle Clip C3	2,5/m ²

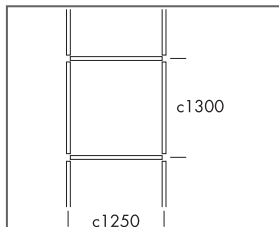

Installation in rectangles

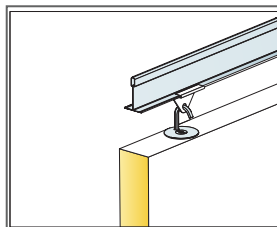

Detail of suspension

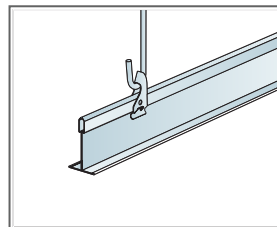

Suspension with Connect Adjustable Hanger and Connect Hanger Clip

Size, mm	Max live load (N)	Min load bearing capacity (N)
1200x600x50	0	160

Live load/load bearing capacity



Ecophon Hygiene Performance™ Wall

Ecophon Hygiene Performance™ Wall is an easy to clean, sound absorbing wall panel system suitable for humid areas. The panels withstand advanced cleaning, such as steam and high/low pressure washing on a regular basis.



TAYS kitchen, Tampere, Finland

SYSTEM RANGE

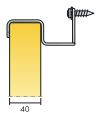

Size, mm	1200x600
Special Fixing	•
Thickness (THK)	40
Inst. Diag.	M467

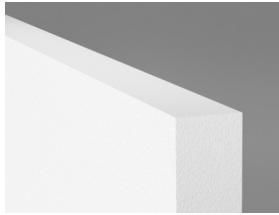

Hygiene Performance Wall

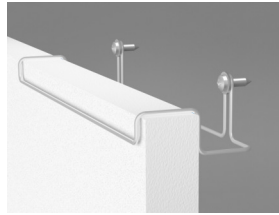

Connect Wall Fixing C3



Hygiene Performance Wall C3 system

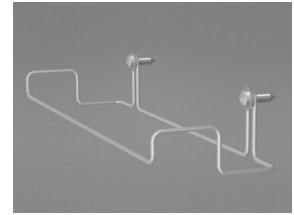

Connect Wall Fixing C3

Acoustic



Sound Absorption:

Test results according to EN ISO 354. Classification according to EN ISO 11654.

α_p , Practical sound absorption coefficient

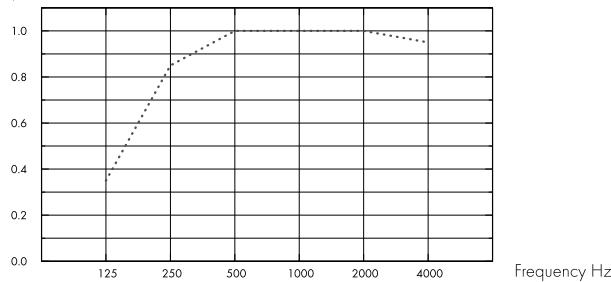

... Hygiene Performance Wall, 80 mm o.d.s.

o.d.s = overall depth of system

THK mm	o.d.s. mm	α_p , Practical sound absorption coefficient						α_w	Sound absorption class
		125 Hz	250 Hz	500 Hz	1000 Hz	2000 Hz	4000 Hz		
40	80	0.35	0.85	1.00	1.00	1.00	0.95	1.00	A

THK mm	o.d.s. mm	NRC	SAA
40	80	0.95	0.95

Indoor Air Quality



Certificate / Label	
Eurofins Indoor Air Comfort®	IAC
French VOC	A
Finnish M1	•



Cradle to Cradle Certified®



This product is Cradle to Cradle Certified® at Bronze level (version 4.0).



Material Health

This product has received a C2C Certified Material Health Certificate™ at the Silver level (standard version 4.0). The C2C Certified Material Health Certificate™ is a verification of the health and safety of a product's composition using the Material Health requirements of the Cradle-to-Cradle Certified Product Standard.



Environmental Footprint

	kg CO ₂ equiv/m ²	Life-cycle stages A1 to C4 from EPD, in conformity with ISO 14025 / EN 15804
Hygiene Performance Wall	7,10	



Circularity

Minimum post-consumer recycled content	54%
Recyclability	Fully recyclable



Fire safety

Country	Class	
Europe	EN 13501-1	A2-s1,d0

The glass wool core of the tiles is tested and classified as non-combustible according to EN ISO 1182.



Humidity Resistance

Class C, relative humidity 95% and 30°C, according to EN 13964:2014



Visual appearance

White 500, nearest NCS colour sample S 0500-N, 84% light reflectance.



Cleanability

Daily dusting and vacuum cleaning. Weekly wet wiping.



Advanced Cleanability

High and low pressure cleaning with water and steam cleaning. Withstand use of hydrogen peroxide vapor.



Surface Endurance

Product tested according to ISO 11998, and withstand 200 cycles.



Chemical resistance/Disinfection

Chemical	Active Substance	Concentration
Actichlor plus	NaDCC (Sodium Dichloroisocyanurate)	1%
LifeClean	Chlorine dioxide	Undiluted
Etanol	Etanol	70%
Chlorine	Sodium Hypochlorite solution	2,5%
Virkon S	Sulfamic acid	1%
Isopropanol	Isopropyl Alcohol	70%
Oxivir Excel	Hydrogen peroxide	0,5%
Sumabac D10	Quaternary ammonium compound, Sodium carbonate	1%
Suredis VT1	n-(3-aminopropyl)-n-dodecylpropan-1,3-diamin	1%
Enduro Chlor VE5	Potassium hydroxide	1,5%
Acipusfoam VF59	Nitric Acid	5%

Tested according to ISO 11998 and withstand the following chemicals or disinfectants.



Mould and Bacterial Resistance

Standard/Method	
ISO 846 A	0
ISO 846 C	0



Clean Room

	Standard/Method	Class
ISO 14644	Particle cleanliness class	ISO 4
NF S 90-351	Microbiological class	M1/area 4
NF S 90-351	Particle elimination kinetics	CP(0,5) 5



Accessibility

The tiles are demountable.



Installation

Installed according to installation diagrams, installation guides and drawing aid. For information regarding minimum overall depth of system see quantity specification.



System weight

The weight of the system (including profile system) should be approximately 3 kg/pcs.



Mechanical properties

See table about Max live load and Min load bearing capacity and Functional demands, Mechanical properties at www.ecophon.com.



CE

Ecophon ceiling systems are CE marked according to the European harmonized standard EN13964:2014. CE marked construction products are covered by a Declaration of Performance (DOP) which enables customers and users to easily compare performance of products available on the European market.

INSTALLATION DIAGRAM (M467) FOR ECOPHON HYGIENE PERFORMANCE™ WALL C3

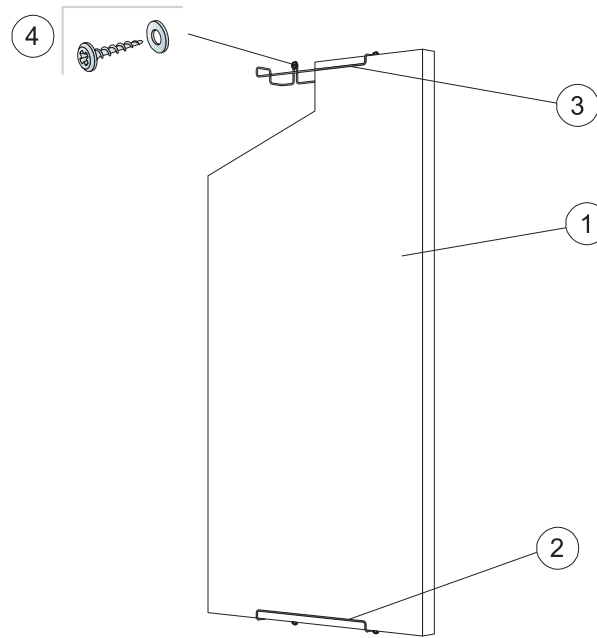

© Saint-Gobain Ecophon AB

QUANTITY SPECIFICATION (EXCL. WASTAGE)

		Size, mm
		1200x600
1	Hygiene Performance Wall	1,4/m ²
2	Connect Wall Fixing C3, vertical installation	2/panel
3	Connect Wall Fixing C3, horizontal installation	4/panel
4	Wall screw, A2 material (not supplied by Ecophon)	2/wall fixing
Δ Min. overall depth of system: 90 mm		-

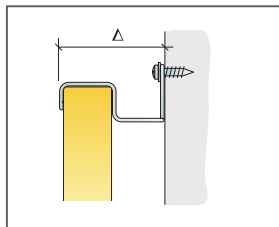

See Quantity Specification

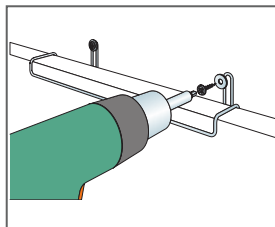

Installation with wall screw in stainless steel (A2) material

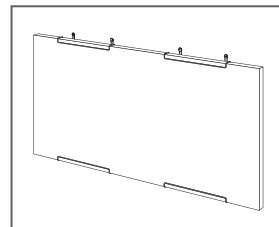

Horizontal installation of Performance Wall C3

Size, mm	Max live load (N)	Min load bearing capacity (N)
1200x600x40	0	-

Live load/load bearing capacity



Ecophon Hygiene Performance™ Care Wall

Ecophon Hygiene Performance™ Care Wall is an easy to clean, sound absorbing wall panel system for healthcare applications or other areas with elevated hygiene standards. The surface is resistant to common detergents and disinfectants. The panels withstand steam cleaning.



Healthcare launch 2019, Sweden

SYSTEM RANGE

 Size, mm	2700x1200
Thinline Profile	•
Thickness (THK)	40
Inst. Diagr.	M610

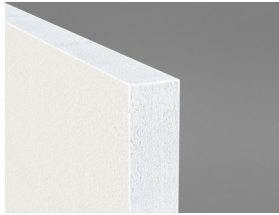

Hygiene Performance Care Wall



Hygiene Performance Care Wall system with Connect Thinline profiles

Acoustic



Sound Absorption:

Test results according to EN ISO 354. Classification according to EN ISO 11654.

α_p , Practical sound absorption coefficient

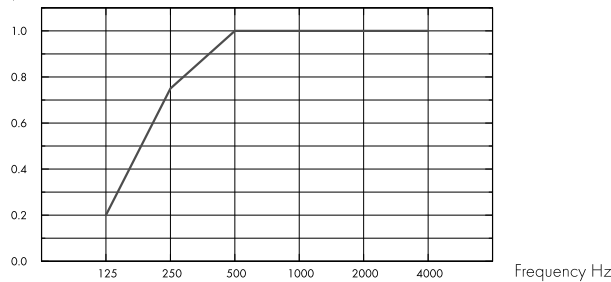

– Hygiene Performance Care Wall 40 mm, 50 mm o.d.s.

o.d.s = overall depth of system

THK mm	o.d.s. mm	α_p , Practical sound absorption coefficient						α_w	Sound absorption class
		125 Hz	250 Hz	500 Hz	1000 Hz	2000 Hz	4000 Hz		
40	50	0.20	0.75	1.00	1.00	1.00	1.00	1.00	A

THK mm	o.d.s. mm	NRC	SAA
40	50	0.95	0.96

Indoor Air Quality



Certificate / Label	
Eurofins Indoor Air Comfort®	IAC
French VOC	A
Finnish M1	•



Cradle to Cradle Certified®



This product is Cradle to Cradle Certified® at Bronze level (version 4.0).

Material Health



This product has received a C2C Certified Material Health Certificate™ at the Silver level (standard version 4.0). The C2C Certified Material Health Certificate™ is a verification of the health and safety of a product's composition using the Material Health requirements of the Cradle-to-Cradle Certified Product Standard.

Circularity



Minimum post-consumer recycled content	58%
Recyclability	Fully recyclable



Fire safety

Country	Class	
Europe	EN 13501-1	A2-s1,d0

The glass wool core of the tiles is tested and classified as non-combustible according to EN ISO 1182.



Humidity Resistance

Class C, relative humidity 95% and 30°C, according to EN 13964:2014



Visual appearance

White 500, nearest NCS colour sample S 0500-N, 84% light reflectance.



Cleanability

Daily dusting and vacuum cleaning. Weekly wet wiping.



Advanced Cleanability

Steam cleaning. Withstand use of hydrogen peroxide vapor.



Surface Endurance

Product tested according to ISO 11998, and withstand 200 cycles.



Chemical resistance/Disinfection

Chemical	Active Substance	Concentration
Actichlor plus	NaDCC (Sodium Dichloroisocyanurate)	1%
LifeClean	Chlorine dioxide	Undiluted
Etanol	Etanol	70%
Chlorine	Sodium Hypochlorite solution	2,5%
Virkon S	Sulfamic acid	1%
Isopropanol	Isopropyl Alcohol	70%
Oxivir Excel	Hydrogen peroxide	0,5%
Sumabac D10	Quaternary ammonium compound, Sodium carbonate	1%
Suredis VT1	n-(3-aminopropyl)-n-dodecylpropan-1,3-diamin	1%
Enduro Chlor VE5	Potassium hydroxide	1,5%
Acipusfoam VF59	Nitric Acid	5%

Tested according to ISO 11998 and withstand the following chemicals or disinfectants.



Mould and Bacterial Resistance

Standard/Method	
ISO 846 A	0
ISO 846 C	0



Clean Room

	Standard/Method	Class
ISO 14644	Particle cleanliness class	ISO 4
NF S 90-351	Microbiological class	M1/area 4
NF S 90-351	Particle elimination kinetics	CP(0,5) 5



Accessibility

The tiles are not demountable except in selected installation diagrams. See quantity specification for more information.



Installation

Installed according to installation diagrams, installation guides and drawing aid. For information regarding minimum overall depth of system see quantity specification.



Mechanical properties

See table about Max live load and Min load bearing capacity and Functional demands, Mechanical properties at www.ecophon.com.



CE

Ecophon ceiling systems are CE marked according to the European harmonized standard EN 13964:2014. CE marked construction products are covered by a Declaration of Performance (DOP) which enables customers and users to easily compare performance of products available on the European market.

INSTALLATION DIAGRAM (M610) FOR ECOPHON HYGIENE PERFORMANCE™ CARE WALL INSTALLATION WITH CONNECT THINLINE PROFILE.

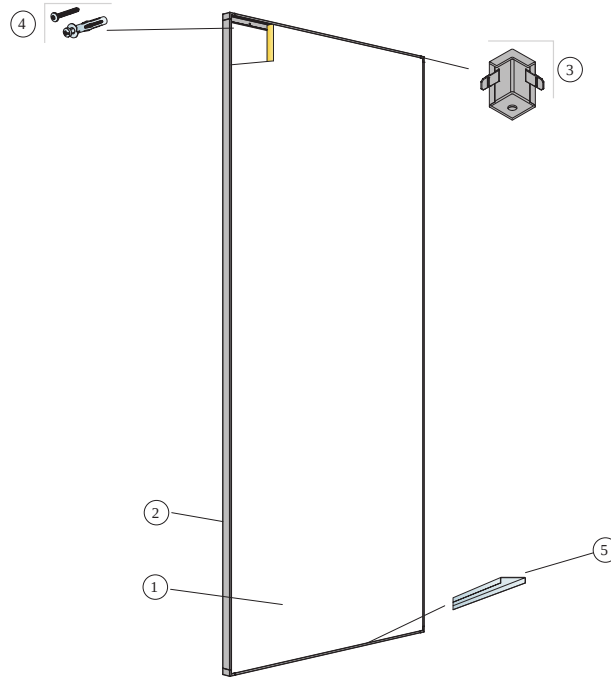

© Saint Gobain Ecophon AB

QUANTITY SPECIFICATION (EXCL. WASTAGE)

		Size, mm
		2700x1200
1	Hygiene Performance Care Wall	0,31/m ²
2	Connect Thinline Profile, L=2658 mm	as required
3	Connect Thinline Corner	as required
4	Installation screw, installed at 200 mm centres (select fastener according to wall material)	as required
5	Connect Thinline Space Bar	as required
Δ Overall depth of system: 45 mm		-

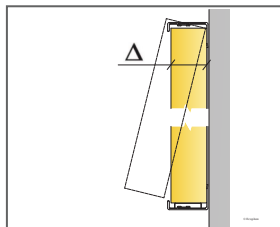

See Quantity specification

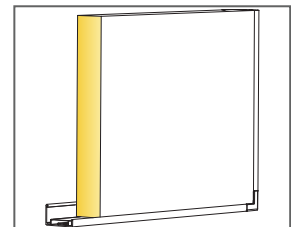

Detail of panel with Thinline system

Ecophon Hygiene Advance™ A

Ecophon Hygiene Advance™ A is a sound-absorbing ceiling with an exposed grid that sustains daily advanced cleaning and disinfection with strong chemicals. Suitable for the most demanding conditions. Available with corrosion class C3 grids for humid areas and C4 grids for constantly wet areas.



SYSTEM RANGE

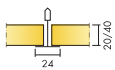

Size, mm	600x600	600x600	1200x600	1200x600
T24	•	•	•	•
Thickness (THK)	20	40	20	40
Inst. Diag.	M246C4, M252C3	M246C4, M252C3	M246C4, M252C3	M246C4, M252C3

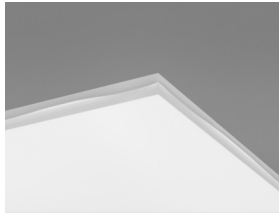

Hygiene Advance A tile

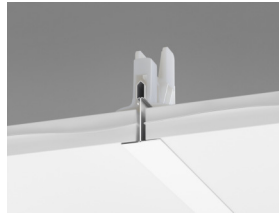

Hygiene Advance A C4 section with Connect Hygiene clip 20



Hygiene Advance A C4 system

Acoustic



Hygiene Advance Technical tile has no performance determined (n.p.d.) for sound absorption.

Sound Absorption:

Test results according to EN ISO 354. Classification according to EN ISO 11654, and the single value ratings for Noise Reduction Coefficient, NRC and Sound Absorption Average, SAA according to ASTM C 423.

α_p , Practical sound absorption coefficient

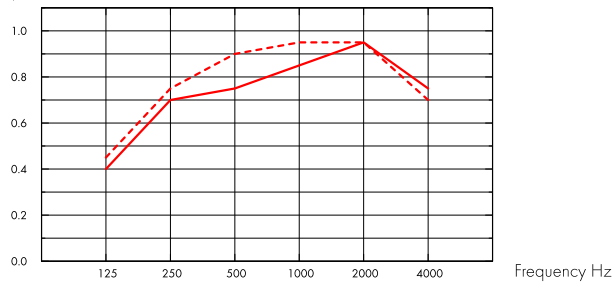

— Hygiene Advance A 20 mm, 200 mm o.d.s.

- - - Hygiene Advance A 40 mm, 200 mm o.d.s.

o.d.s = overall depth of system

THK mm	o.d.s. mm	α_p , Practical sound absorption coefficient						α_w	Sound absorption class
		125 Hz	250 Hz	500 Hz	1000 Hz	2000 Hz	4000 Hz		
20	200	0.40	0.70	0.75	0.85	0.95	0.75	0.85	B
40	200	0.45	0.75	0.90	0.95	0.95	0.70	0.90	A

THK mm	o.d.s. mm	NRC	SAA
20	200	0.80	0.76
20	400	0.80	0.79
40	200	0.75	0.76
40	400	0.75	0.76

Indoor Air Quality



Certificate / Label	
Eurofins Indoor Air Comfort®	IAC Gold
French VOC	A+
Finnish M1	•



Environmental Footprint



	kg CO ₂ equiv./m ²
Advance A 20mm	9,32
Advance A 40mm	16,23

Life-cycle stages A1 to C4 from EPD, in conformity with ISO 14025 / EN 15804



Circularity

Minimum post-consumer recycled content	59%
Recyclability	Fully recyclable



Fire safety

Country	Class	
Europe	EN 13501-1	A2-s1,d0

The glass wool core of the tiles is tested and classified as non-combustible according to EN ISO 1182.



Humidity Resistance

Class C, relative humidity 95% and 30°C, according to EN 13964:2014



Visual appearance

White 141, nearest NCS colour sample S 1000-N, 73% light reflectance. Please note: There is a small difference in gloss and appearance between the Hygiene Advance tile and the Hygiene Advance technical tile.



Cleanability

Daily dusting, vacuum cleaning and wet wiping.



Advanced Cleanability

High and low pressure cleaning with water and steam cleaning. Withstand use of hydrogen peroxide vapor and compatible with UV-C disinfection, BIFMA HCF 8.1-2019.



Chemical resistance/Disinfection

Chemical	Concentration
Formalin	37%
Ammoniac	25%
Hydrogen peroxide	30%
Sulfuric acid	5%
Phosphoric acid	30%
Peracetic acid	15%
Hydrochloric acid	5%
Isopropanol	100%
Sodium hydroxide	5%
Sodium hypochlorite	5%

Tested according to ISO 2812-1 and classified according to ISO 4628-1 with excellent result for the following chemicals.



Mould and Bacterial Resistance

Standard/Method	
ISO 846 A	1
ISO 846 C	0



Clean Room

	Standard/Method	Class
ISO 14644	Particle cleanliness class	ISO 3
NF S 90-351	Microbiological class	M1/area 4
NF S 90-351	Particle elimination kinetics	CP(0,5) 1



Air permeability

Product	Q50, positive (m ³ /m ² /h)	Q50, positive (l/s/m ²)	Q50, negative (m ³ /m ² /h)	Q50, negative (l/s/m ²)
Hygiene Advance A 20mm	38,8	10,8	28,6	7,9
Hygiene Advance A 40mm	10,3	2,9	10,0	2,8

Measured at positive respective negative room pressure at 50 Pa (Q50) EN ISO 9972 :2015



Accessibility

The tiles are demountable. Minimum demounting depth according to installation diagram. The tiles are secured using Connect Hygiene Clip to allow for effective cleaning. The clips are easily removable from above the ceiling. Connect Democlips 20 C4 are available to simplify access to the ceiling void.



Installation

Installed according to installation diagrams, installation guides and drawing aid. Cut tiles must be sealed with Connect Hygiene Advance Tape. Penetrations must be sealed with a suitable sealant.



System weight

The weight of the system (including suspension grid) should be approximately 3 kg/m² for 20 mm thickness and 4,5 kg/m² for 40 mm thickness.



Mechanical properties

See table about Max live load and Min load bearing capacity and Functional demands, Mechanical properties at www.ecophon.com.



CE

Ecophon ceiling systems are CE marked according to the European harmonized standard EN13964:2014. CE marked construction products are covered by a Declaration of Performance (DOP) which enables customers and users to easily compare performance of products available on the European market.

INSTALLATION DIAGRAM (M246) FOR ECOPHON HYGIENE ADVANCE™ A C4

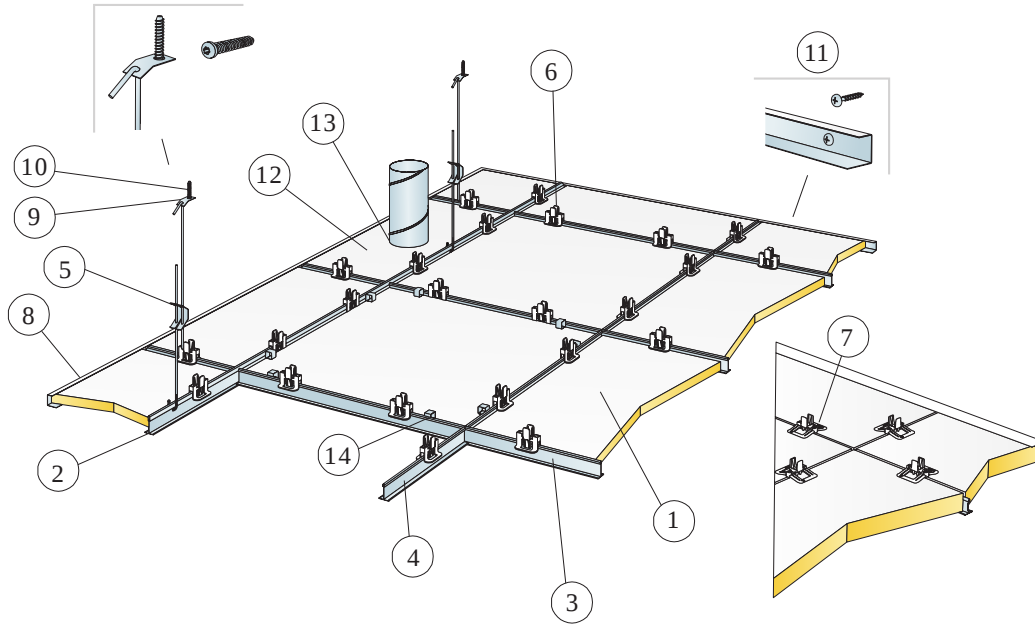

© Saint-Gobain Ecophon AB

QUANTITY SPECIFICATION (EXCL. WASTAGE)

	Size, mm	
	600x600	1200x600
1 Hygiene Advance A	2,8/m ²	2,8/m ²
2 Connect T24 Main Runner C4, c1200	0,9m/m ²	0,9m/m ²
3 Connect T24 Cross Tee C4, L=1200, c600	1,7m/m ²	1,7m/m ²
4 Connect T24 Cross Tee C4, L=600	0,9m/m ²	0,9m/m ²
5 Connect Adjustable Hanger C4, c1200, (max 600 mm distance from wall)	0,7/m ²	0,7/m ²
6 Connect Hygiene Clip 20	11/m ²	11/m ²
7 Connect Hygiene Clip 40 C4	11/m ²	11/m ²
8 Connect Channel Trim C4, fixed at c300 mm	as required	as required
9 Connect Fixing Plate C4	0,7/m ²	0,7/m ²
10 Connect Anchor Screw C4	0,7/m ²	0,7/m ²
11 Connect Installation Screw C4	3,4/m Channel trim C4	
12 Hygiene Advance Technical Tile	as required	as required
13 Joint sealant (not supplied by Ecophon)	as required	as required
14 Connect Demo Clip 20 C4, (where access is needed)	as required	as required
15 Connect Hygiene Advance Tape	as required	as required
Δ Min. overall depth of system: 150 mm	-	-
δ Min. demounting depth: 150 mm	-	-

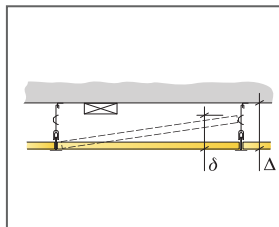

See Quantity Specification

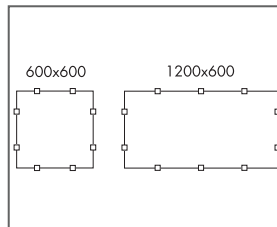

Arrangement of clips

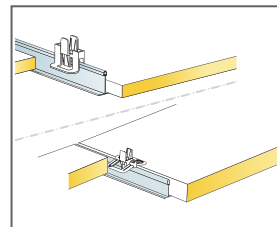

Clip for keeping tiles in place for 20/40 mm tiles

Size, mm	Max live load (N)	Min load bearing capacity (N)
600x600x20	40	160
600x600x40	40	160
1200x600x20	40	160
1200x600x40	40	160

Live load/load bearing capacity

INSTALLATION DIAGRAM (M252) FOR ECOPHON HYGIENE ADVANCE™ A C3

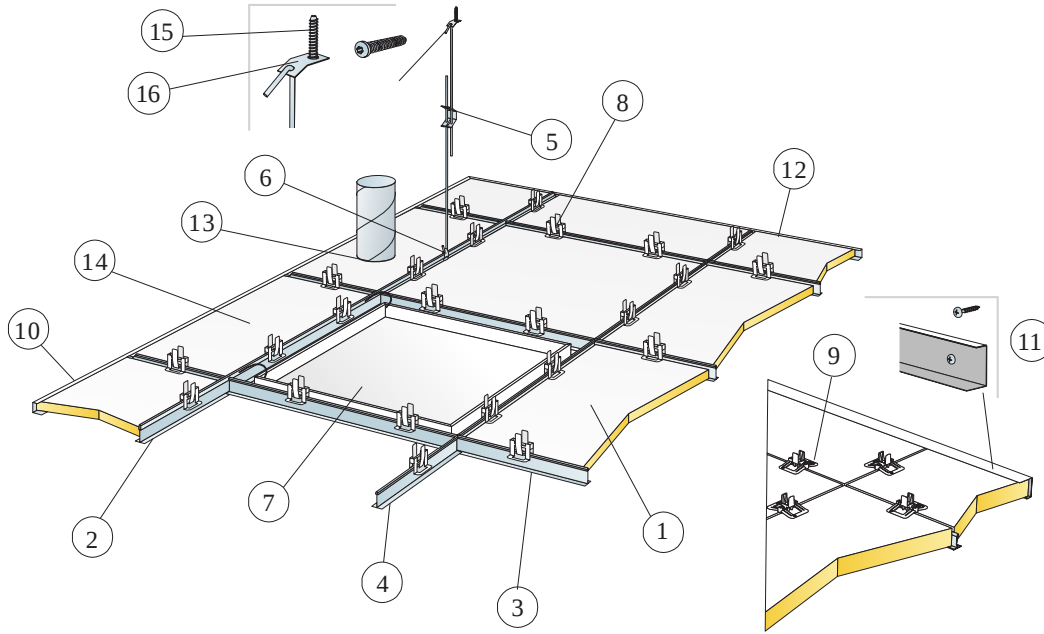

© Saint-Gobain Ecophon AB

QUANTITY SPECIFICATION (EXCL. WASTAGE)

		Size, mm	
		600x600	1200x600
1	Hygiene Advance A	2,8/m ²	2,8/m ²
2	Connect T24 Main Runner C3, installed at 1200 mm centres	0,9m/m ²	0,9m/m ²
3	Connect T24 Cross Tee C3, L=1200 mm, installed at 600 mm centres	1,7m/m ²	1,7m/m ²
4	Connect T24 Cross Tee C3, L=600 mm	0,9m/m ²	0,9m/m ²
5	Connect Adjustable Hanger C3, c1200 (max distance from wall 600 mm)	0,7/m ²	0,7/m ²
6	Connect Hanger Clip (not to be used in swimming hall environments)	0,7/m ²	0,7/m ²
7	Connect Inspection Hatch C3	as required	as required
8	Connect Hygiene Clip 20	11/m ²	11/m ²
9	Connect Hygiene Clip 40	11/m ²	11/m ²
10	Connect Channel Trim C3, fixed c300 (for 20 mm thickness)	as required	as required
11	Connect Channel Trim C3, fixed c300 (for 40 mm thickness)	as required	as required
12	Connect Hygiene Advance Tape	as required	as required
13	Joint sealant (not supplied by Ecophon)	as required	as required
14	Hygiene Advance Technical Tile	as required	as required
15	Connect Anchor Screw C4	0,7/m ²	0,7/m ²
16	Connect Fixing Plate C4	0,7/m ²	0,7/m ²
Δ Min. overall depth of system: 150 mm		-	-
δ Min. demounting depth 20 mm: 150 mm		-	-
δ Min. demounting depth 40 mm: 170 mm		-	-

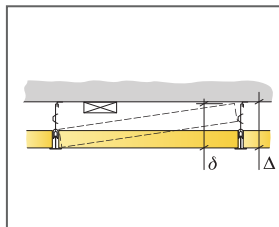

See Quantity Specification

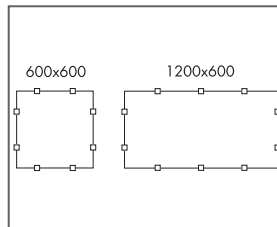

Arrangement of clips

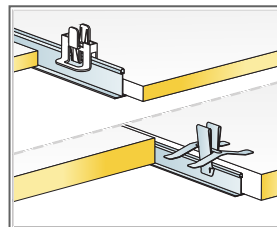

Clips for keeping tiles in place

Size, mm	Max live load (N)	Min load bearing capacity (N)
600x600x20	40	160
600x600x40	40	160
1200x600x20	40	160
1200x600x40	40	160

Live load/load bearing capacity

Ecophon Hygiene Advance™ Baffle

Ecophon Hygiene Advance™ Baffle is a vertical baffle that withstands daily advanced cleaning and disinfection with strong chemicals. Suitable for the most demanding conditions, including airborne grease and dirt particles.

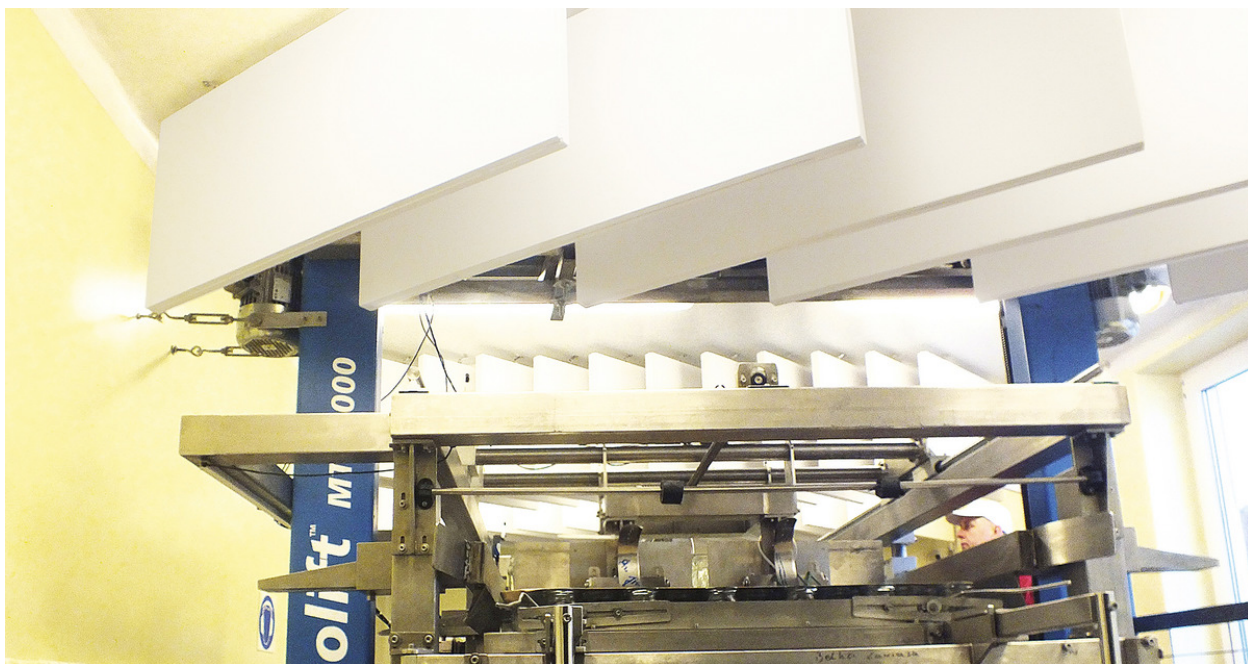

Katrzyn Malonezy, Poland

SYSTEM RANGE



Size, mm	1200x600
T24	•
Thickness (THK)	40
Inst. Diag.	M259, M260

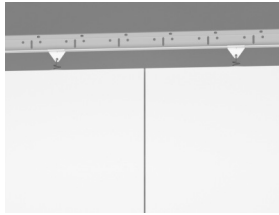

Hygiene Advance Baffle C3 in rows

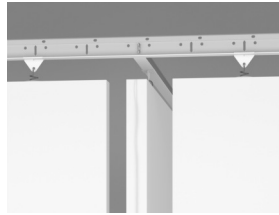

Hygiene Advance Baffle C3 in rectangles

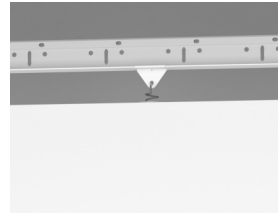

Hygiene Advance Baffle C3 with Connect Baffle clip



Hygiene Advance Baffle

Acoustic



Sound Absorption:

Test results according to EN ISO 354:2003 NOTE: Results shown are not comparable with results according to older versions of this standard due to discrepancies in test method. Classification according to EN ISO 11654, and the single value ratings for Noise Reduction Coefficient, NRC and Sound Absorption Average, SAA according to ASTM C 423.

α_p , Practical sound absorption coefficient

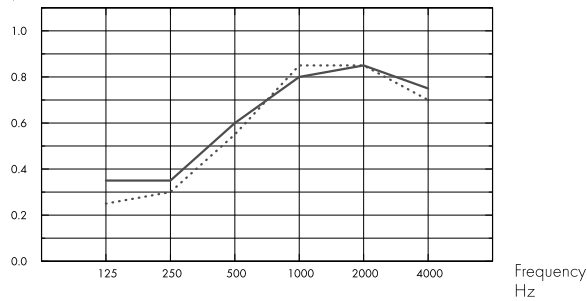

... Advance Baffle in rows, c600 mm, with ~1,4 baffles/m² ceiling area, 600 mm o.d.s.

– Advance Baffle in rectangles, with ~1,3 baffles/m² ceiling area, 600 mm o.d.s.

o.d.s = overall depth of system

	THK mm	o.d.s. mm	α_p , Practical sound absorption coefficient					α_w	Sound absorption class	
			125 Hz	250 Hz	500 Hz	1000 Hz	2000 Hz			4000 Hz
in rows	40	600	0.25	0.30	0.55	0.85	0.85	0.70	0.55	D
in rectangles	40	600	0.35	0.35	0.60	0.80	0.85	0.75	0.60	C

THK mm	o.d.s. mm	NRC	SAA
40	600	1.00	1.00
40	600	1.00	1.00

Indoor Air Quality



Certificate / Label	
Eurofins Indoor Air Comfort®	IAC Gold
French VOC	A+
Finnish M1	•



Environmental Footprint



	kg CO ₂ equiv/m ²
Advance Baffle	16,23

life-cycle stages A1 to C4 from EPD, in conformity with ISO 14025 / EN 15804

Circularity



Minimum post-consumer recycled content	64%
Recyclability	Fully recyclable



Fire safety

Country	Class	
Europe	EN 13501-1	A2-s1,d0

The glass wool core of the tiles is tested and classified as non-combustible according to EN ISO 1182.



Humidity Resistance

Class C, relative humidity 95% and 30°C, according to EN 13964:2014



Visual appearance

White 141, nearest NCS colour sample S 1000-N, 73% light reflectance.



Cleanability

Daily dusting, vacuum cleaning and wet wiping.



Advanced Cleanability

High and low pressure cleaning with water and steam cleaning. Withstand use of hydrogen peroxide vapor and compatible with UV-C disinfection, BIFMA HCF 8.1-2019.



Chemical resistance/Disinfection

Chemical	Concentration
Formalin	37%
Ammoniac	25%
Hydrogen peroxide	30%
Sulfuric acid	5%
Phosphoric acid	30%
Peracetic acid	15%
Hydrochloric acid	5%
Isopropanol	100%
Sodium hydroxide	5%
Sodium hypochlorite	5%

Tested according to ISO 2812-1 and classified according to ISO 4628-1 with excellent result for the following chemicals.



Mould and Bacterial Resistance

Standard/Method	
ISO 846 A	1
ISO 846 C	0



Clean Room

	Standard/Method	Class
ISO 14644	Particle cleanliness class	ISO 3
NF S 90-351	Microbiological class	M1/area 4
NF S 90-351	Particle elimination kinetics	CP(0,5) 1



Accessibility

The tiles are demountable.



Installation

Installed according to installation diagrams, installation guides and drawing aid. Cut tiles must be sealed with Connect Hygiene Advance Tape. Penetrations must be sealed with a suitable sealant.



System weight

The weight of the system (including suspension grid) should be approximately 4 kg/m².



Mechanical properties

See table about Max live load and Min load bearing capacity and Functional demands, Mechanical properties at www.ecophon.com.



CE

Ecophon ceiling systems are CE marked according to the European harmonized standard EN13964:2014. CE marked construction products are covered by a Declaration of Performance (DOP) which enables customers and users to easily compare performance of products available on the European market.

INSTALLATION DIAGRAM (M259) FOR ECOPHON HYGIENE ADVANCE™ Baffle C3 (IN ROWS)

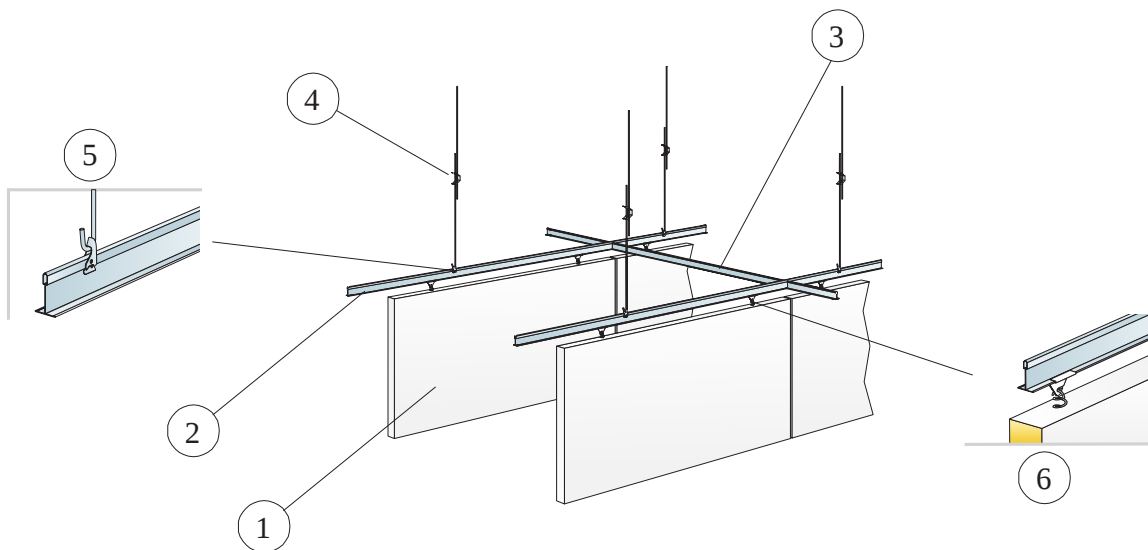

© Saint-Gobain Ecophon AB

QUANTITY SPECIFICATION (EXCL. WASTAGE)

		Size, mm
		1200x600
1	Hygiene Advance Baffle	1,4/m ²
2	Connect T24 Main Runner C3, installed at 600 mm centres	1,7m/m ²
3	Connect T24 Cross Tee C3, L=600 mm, installed at 1800 mm centres	0,6m/m ²
4	Connect Adjustable Hanger C3 c1200	1,4/m ²
5	Connect Hanger Clip	1,4/m ²
6	Connect Baffle Clip C3	2,8/m ²

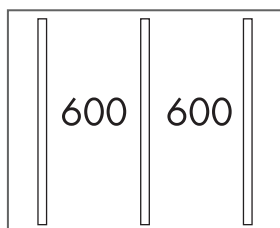

Installation in rows

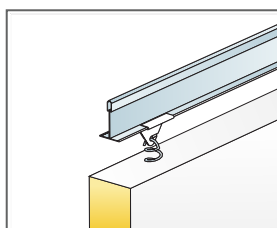

Detail of suspension

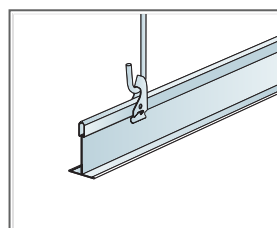

Suspension with Connect Adjustable Hanger and Connect Hanger Clip

Size, mm	Max live load (N)	Min load bearing capacity (N)
1200x600x40	0	160

Live load/load bearing capacity

INSTALLATION DIAGRAM (M260) FOR ECOPHON HYGIENE ADVANCE™ Baffle C3 (IN RECTANGLES)

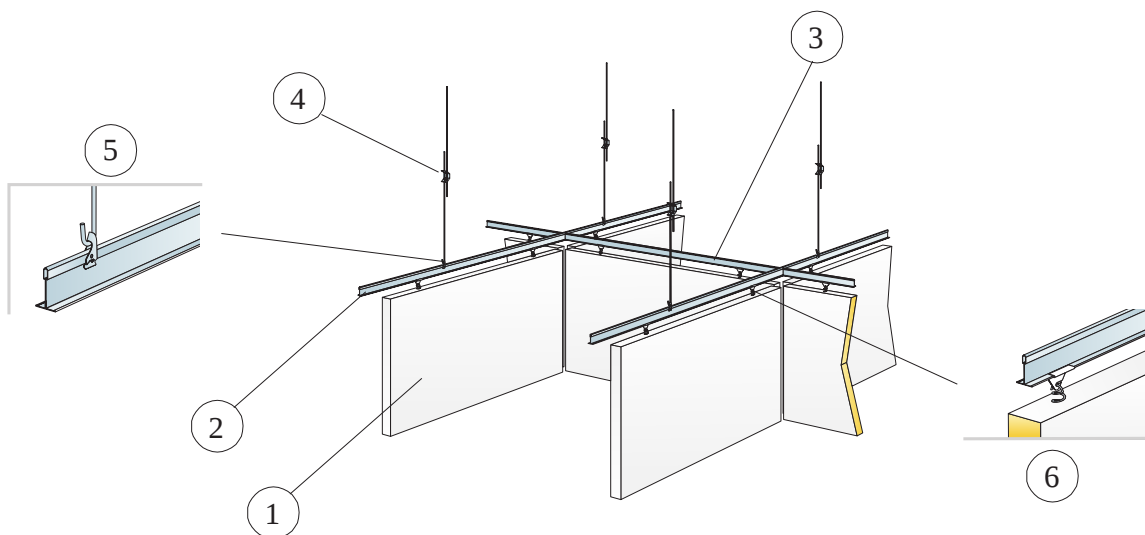

© Saint-Gobain Ecophon AB

QUANTITY SPECIFICATION (EXCL. WASTAGE)

		Size, mm
		1200x600
1	Hygiene Advance Baffle	1,3/m ²
2	Connect T24 Main Runner C3, installed at 1250 mm centres	0,8m/m ²
3	Connect T24 Cross Tee C3, L=1250 mm, installed at 1300 mm centres	0,8m/m ²
4	Connect Adjustable Hanger C3	0,7/m ²
5	Connect Hanger Clip	0,7/m ²
6	Connect Baffle Clip C3	2,5/m ²

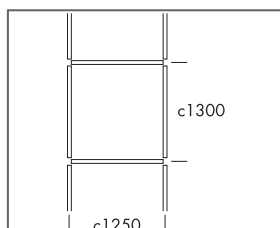

Installation in rectangles

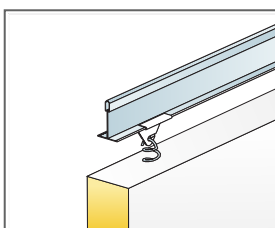

Detail of suspension

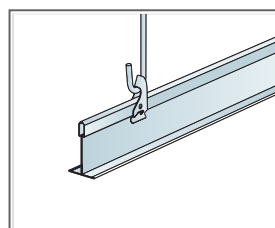

Suspension with Connect Adjustable Hanger and Connect Hanger Clip

Size, mm	Max live load (N)	Min load bearing capacity (N)
1200x600x40	0	160

Live load/load bearing capacity

Ecophon Hygiene Advance™ Wall

Ecophon Hygiene Advance™ Wall is a wall panel that withstands daily advanced cleaning and disinfection with strong chemicals. Suitable for the most demanding conditions, including airborne grease and dirt particles.



Easyfood, Kolding, Denmark

SYSTEM RANGE

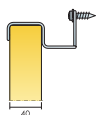

Size, mm	1200x600
Special Fixing	•
Thickness (THK)	40
Inst. Diagr.	M258



Hygiene Advance Wall



Connect Wall fixing C3



Hygiene Advance Wall C3 system

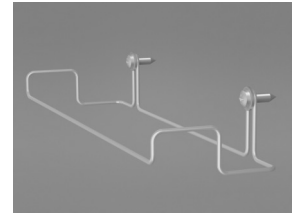

Connect Wall Fixing C3

Acoustic



Sound Absorption:

Test results according to EN ISO 354. Classification according to EN ISO 11654.

α_p , Practical sound absorption coefficient

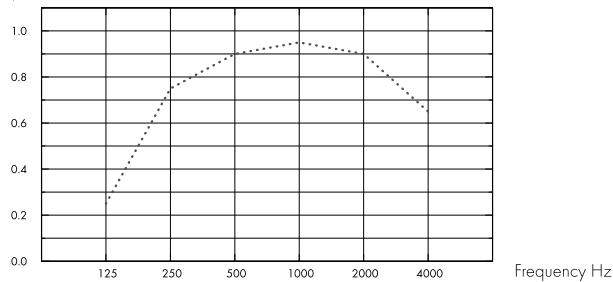

... Hygiene Advance Wall, 80 mm o.d.s.

o.d.s = overall depth of system

THK mm	o.d.s. mm	α_p , Practical sound absorption coefficient						α_w	Sound absorption class
		125 Hz	250 Hz	500 Hz	1000 Hz	2000 Hz	4000 Hz		
40	80	0.25	0.75	0.90	0.95	0.90	0.65	0.85	B



Indoor Air Quality

Certificate / Label	
Eurofins Indoor Air Comfort®	IAC Gold
French VOC	A+
Finnish M1	•



Environmental Footprint

	kg CO ₂ equiv/m ²	Life-cycle stages A1 to C4 from EPD, in conformity with ISO 14025 / EN 15804
Advance Wall	16,23	



Circularity

Minimum post-consumer recycled content	64%
Recyclability	Fully recyclable



Fire safety

Country	Class
Europe	EN 13501-1 A2-s1,d0

The glass wool core of the tiles is tested and classified as non-combustible according to EN ISO 1182.



Humidity Resistance

Class C, relative humidity 95% and 30°C, according to EN 13964:2014



Visual appearance

White 141, nearest NCS colour sample S 1000-N, 73% light reflectance.



Cleanability

Daily dusting, vacuum cleaning and wet wiping.



Advanced Cleanability

High and low pressure cleaning with water and steam cleaning. Withstand use of hydrogen peroxide vapor and compatible with UV-C disinfection, BIFMA HCF 8.1-2019.



Chemical resistance/Disinfection

Chemical	Concentration
Formalin	37%
Ammoniac	25%
Hydrogen peroxide	30%
Sulfuric acid	5%
Phosphoric acid	30%
Peracetic acid	15%
Hydrochloric acid	5%
Isopropanol	100%
Sodium hydroxide	5%
Sodium hypochlorite	5%

Tested according to ISO 2812-1 and classified according to ISO 4628-1 with excellent result for the following chemicals.



Mould and Bacterial Resistance

Standard/Method	
ISO 846 A	1
ISO 846 C	0



Clean Room

	Standard/Method	Class
ISO 14644	Particle cleanliness class	ISO 3
NF S 90-351	Microbiological class	M1/area 4
NF S 90-351	Particle elimination kinetics	CP(0,5) 1



Accessibility

The tiles are demountable.



Installation

Installed according to installation diagrams, installation guides and drawing aid. For information regarding minimum overall depth of system see quantity specification.



System weight

The weight of the system (including profile system) should be approximately 3 kg/pcs.



Mechanical properties

See table about Max live load and Min load bearing capacity and Functional demands, Mechanical properties at www.ecophon.com.



CE

Ecophon ceiling systems are CE marked according to the European harmonized standard EN13964:2014. CE marked construction products are covered by a Declaration of Performance (DOP) which enables customers and users to easily compare performance of products available on the European market.

INSTALLATION DIAGRAM (M258) FOR ECOPHON HYGIENE ADVANCE™ WALL C3

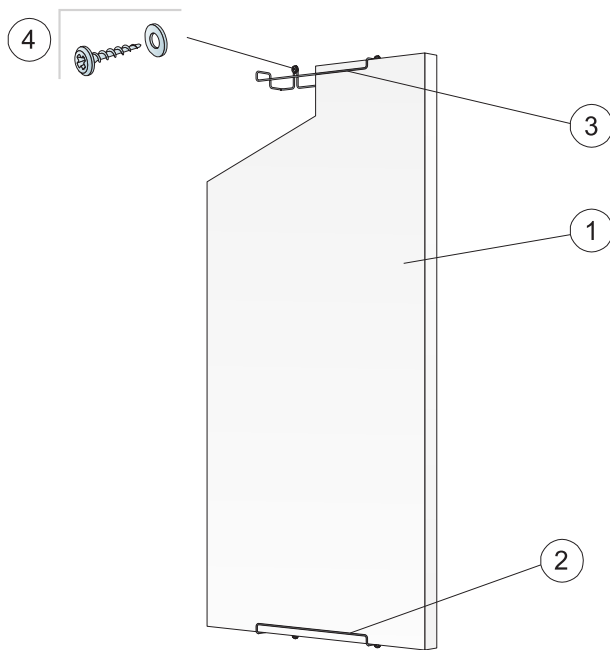

© Saint-Gobain Ecophon AB

QUANTITY SPECIFICATION (EXCL. WASTAGE)

		Size, mm
		1200x600
1	Hygiene Advance Wall	1,4/m ²
2	Connect Wall Fixing C3, vertical installation	2/panel
3	Connect Wall Fixing C3, horizontal installation	4/panel
4	Wall screw, A2 material (not supplied by Ecophon)	2/wall fixing
Δ Min. overall depth of system: 90 mm		-

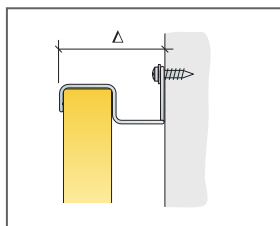

See Quantity Specification

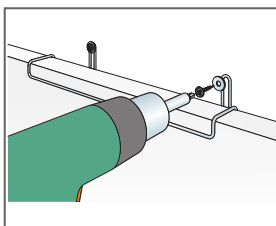

Installation with wall screw in stainless steel (A2) material

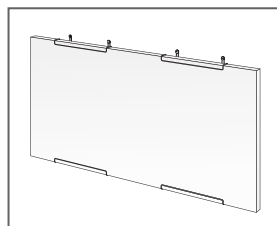

Horizontal installation of Advance Wall C3

Size, mm	Max live load (N)	Min load bearing capacity (N)
1200x600x40	0	-

Live load/load bearing capacity